



# PREMIUM ENTRANCE MATTING SYSTEMS

## TECHNICAL DOCUMENTATION



Handmade  
in Germany



**GEGGUS**<sup>®</sup>

[www.geggus.ie](http://www.geggus.ie)

# CONTENT



## 1

### PLANNING FOR ENTRANCE AREAS

Smart planning and construction. Bim-based work.	5
For systematic protection. Assured value for money.	6
Three clean-off zones. Combined in a single solution.	7
The ideal level of protection. In every area.	8
Mat heights · Load	10
Traffic	11
Mat heights · Inlays/Additional profiles · Areas of Use	12
Top Clean Mat Systems prevent impact sound	13
Planning for mats, frames and dirt collecting	14
Connectors for multi-part mats	15
Insertion tolerance/ Thermal expansion during installation	16
Custom-Fit templates for special mat shapes	17
Special shapes frames and matting	18
Cleaning and maintenance	19
Ribbed carpet colours · Ribbed carpet properties	20
Grooved Rubber · Cassette Brushes · Brush Strips	21



## 2

### MATTING SYSTEMS FOR INDOOR AREAS

<b>NORMAL TRAFFIC</b>	
Top Clean TREND® XL GREEN MOTION with Eco-Friendly Ribbed Carpet	24
Top Clean LIGHT LIGHT XL 12 for installation with low installation height	25
Top Clean TREND® for normal load	26
Top Clean TREND® XL for large areas	28
<b>HIGH TRAFFIC · EXTREME TO HEAVY LOAD</b>	
Top Clean STABIL for heavy usage	30
Top Clean STABIL XL for heavy usage and large areas	32
Top Clean OBJEKT for extreme heavy usage	34
Top Clean HIGH for extreme usage and heavy load	36



## 3

### MATTING SYSTEMS FOR OUTDOOR AREAS

<b>NORMAL TRAFFIC</b>	
Top Clean TREND® for normal load	40
Top Clean TREND® XL for large areas	42
Top Clean BRUSH Brush Strip	52
<b>HIGH TRAFFIC · EXTREME TO HEAVY LOAD</b>	
Top Clean STABIL for heavy load	44
Top Clean STABIL XL for large areas	46
Top Clean OBJEKT for extreme load	48
Top Clean HIGH for extreme and heavy load	50



**4**

**SAFETY IN  
ENTRANCE AREAS**

Safe Clean TREND:  
A luminescent safety mat  
combination **54**

Visual and tactile  
guidance systems for  
entrance Areas **56**



**5**

**DESIGN IN  
ENTRANCE AREAS**

Top Clean TREND® CURVE  
for exclusive  
entrance areas **61**

Matting systems in  
your corporate design **62**

Stainless Steel profile  
with logo **63**

Logo profile with  
LED illumination **63**

Powder-coated profiles  
according to RAL chart **64**

Anodised profile  
surfaces **64**

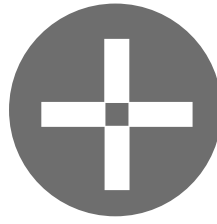

**6**

**ACCESSORIES  
MAINTENANCE**

SPEZIAL angel frame **66**

T-Bars **66**

Installation guide  
for frames **67**

Ramped edge frame **68**

Dirt collection trays **69**

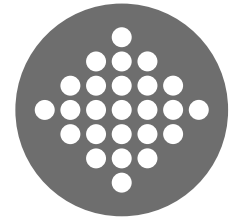

**7**

**UNIVERSAL  
MATS**

MULTICLEAN  
Surface lay barrier mat **72**

LOGOCLEAN Indoor  
Surface lay barrier mat **73**

ENTER  
Durable carpeting  
with rep surface **74**

MASTER  
Coarse haired rep mat **75**

KARO AS MINI  
Honeycomb rubber mat **76**

KARO AS  
Honeycomb rubber mat **77**

DOMINO  
Honeycomb rubber mat **78**

WALK ribbed mat **79**



# 1

## PLANNING FOR ENTRANCE AREAS

- 5 SMART PLANNING AND CONSTRUCTION. BIM-BASED WORK.
- 6 FOR SYSTEMATIC PROTECTION. ASSURED VALUE FOR MONEY.
- 7 THREE CLEAN-OFF ZONES. COMBINED IN A SINGLE SOLUTION.
- 8 THE IDEAL LEVEL OF PROTECTION. IN EVERY AREA.
- 10 MAT HEIGHTS · LOAD
- 11 TRAFFIC
- 12 MAT HEIGHTS · INLAYS/ADDITIONAL PROFILES · AREAS OF USE
- 13 TOP CLEAN MAT SYSTEMS PREVENT IMPACT SOUND
- 14 PLANNING FOR MATS, FRAMES AND DIRT COLLECTING
- 15 CONNECTORS FOR MULTI-PART MATS
- 16 INSERTION TOLERANCE/  
THERMAL EXPANSION DURING INSTALLATION
- 17 CUSTOM-FIT TEMPLATES FOR SPECIAL MAT SHAPES
- 18 SPECIAL SHAPES FRAMES AND MATTING
- 19 CLEANING AND MAINTENANCE
- 20 RIBBED CARPET COLOURS · RIBBED CARPET PROPERTIES
- 21 GROOVED RUBBER · CASSETTE BRUSHES · BRUSH STRIPS



# SMART PLANNING AND CONSTRUCTION. BIM-BASED WORK.



Working digitally is business as usual for you. And for us too. We also use BIM (building information modelling) – the efficient, model-based process for joint project planning and implementation. For example, you can integrate our Top Clean doormat systems directly into your three-dimensional digital model. The necessary digital data is available for you to download at any time.

Further information can be found on our website.

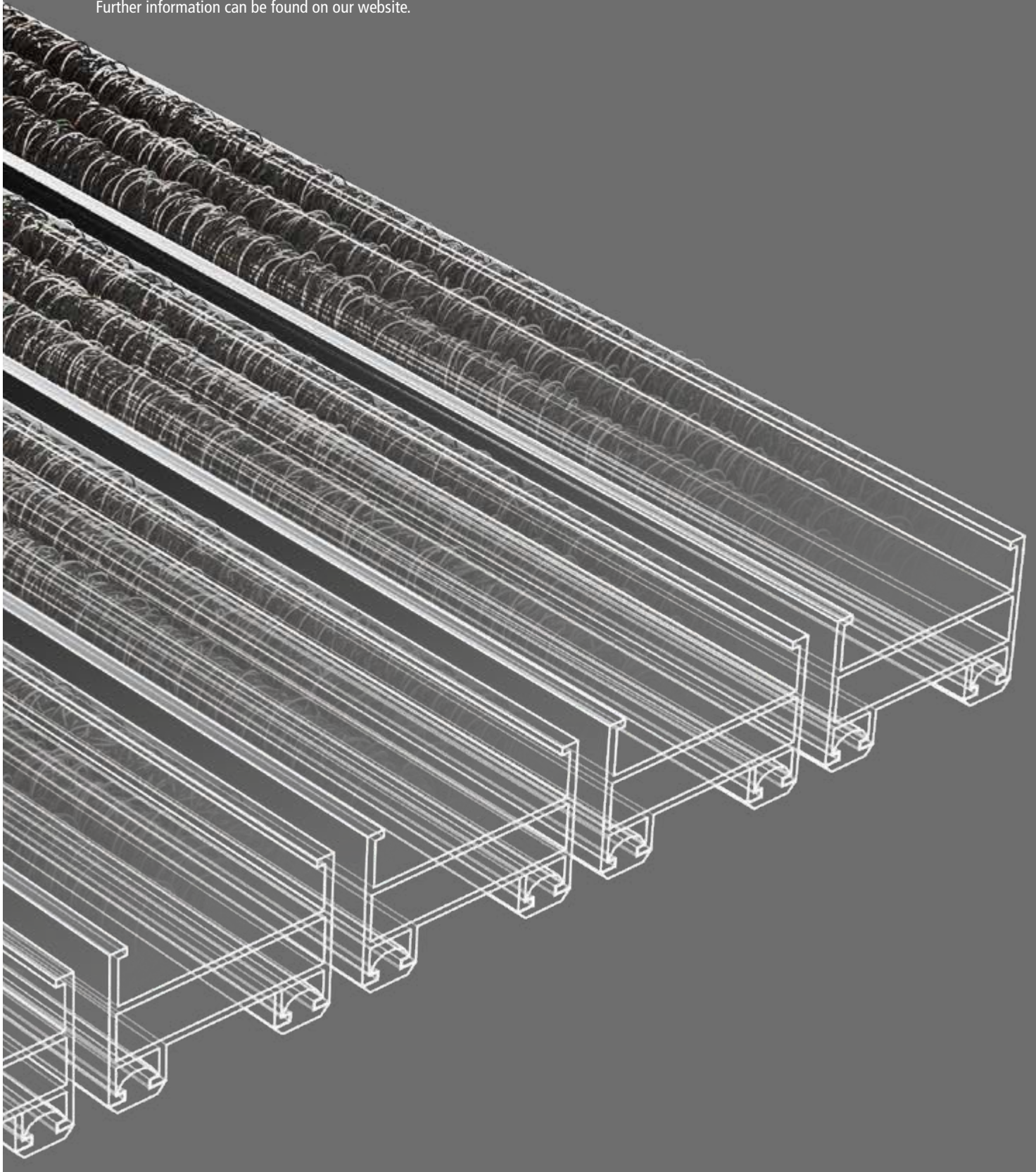

## FOR SYSTEMATIC PROTECTION. ASSURED VALUE FOR MONEY.

Our 3-zone solution takes dirt collection to a new dimension. With a universal design, our entrance matting systems can be ideally aligned with the respective requirements – be it indoors, outside the building or in the intermediate zones – and combined to form perfect individual clean-off zones.

Systematic step by step: Our profile inlays with various combinations of materials ensure that moisture and coarse dirt are reliably removed from shoe soles and not carried further indoors – before people actually enter the building and especially in frequently used entrance areas.

We also take a systematic approach to the issue of safety. Protection against moisture and dirt, combined with the anti-slip function, lead to a lasting reduction in the risk of accidents and ensure greater safety.

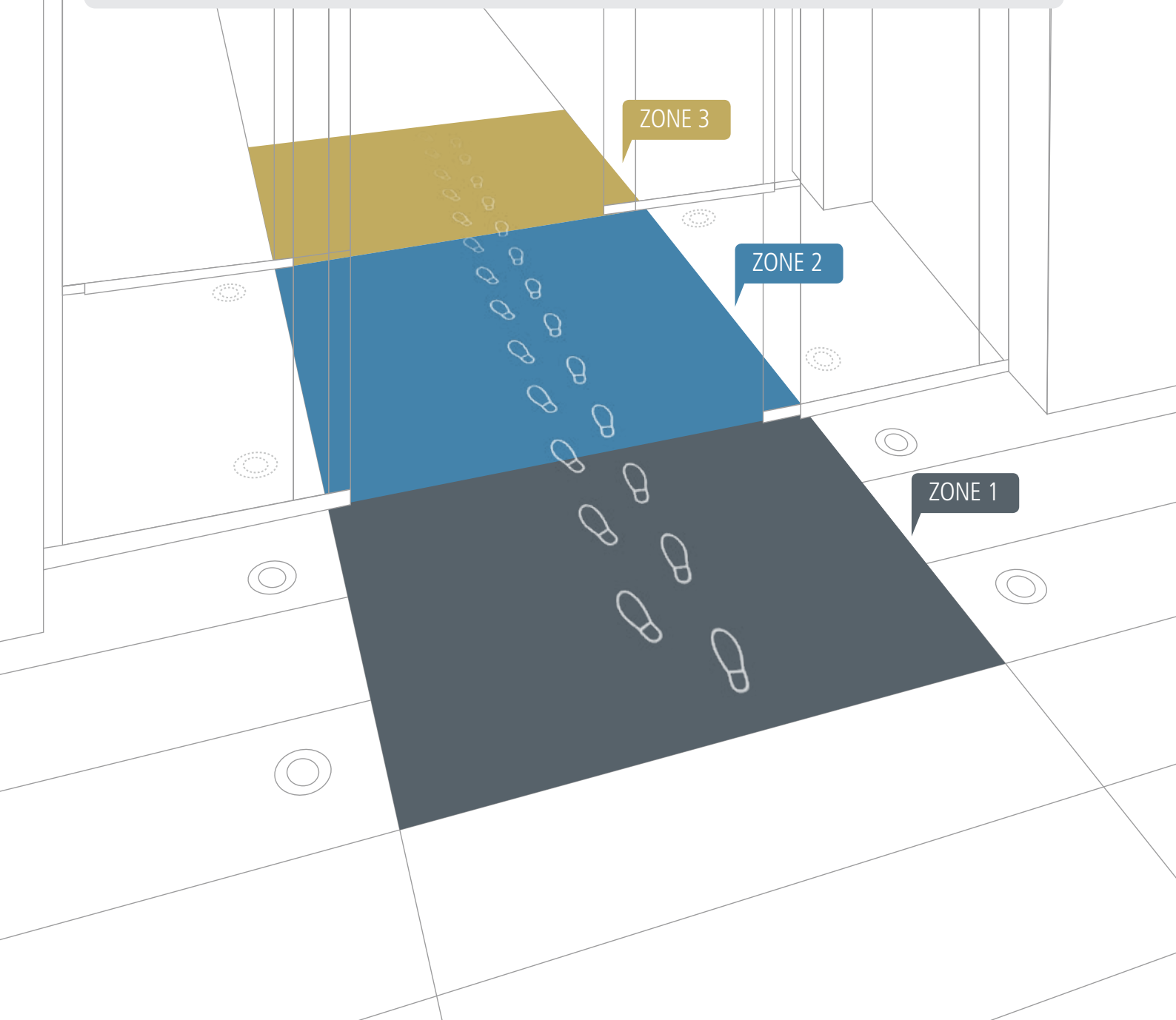

# THREE CLEAN-OFF ZONES. COMBINED IN A SINGLE SOLUTION.

**ZONE 1**

**OUTDOOR AREA**

**Absorption of coarse dirt:**  
Removal of dirt before entering the building

**Effect:**  
Increased effectiveness of subsequent entrance mats

**Advantage:**  
Protection against coarse dirt and moisture

**PRODUCTS:**  
Matting systems for outdoor areas

**ZONE 2**

**INTERMEDIATE AREA**

**Frequently used entrance areas:**  
Efficient removal of even large quantities of dirt

**Effect:**  
Reinforced protection function in combination with zone 1 entrance mats

**Advantage:**  
Protection against coarse dirt and moisture

**PRODUCTS:**  
Matting systems for indoor areas  
Matting systems for outdoor areas

**ZONE 3**

**OUTDOOR AREA**

**Absorption of fine dirt:**  
Reliable protection against fine dirt particles and residual moisture

**Effect:**  
Lasting absorption of persistent dirt and moisture

**Advantage:** Additionally reduces dirt and moisture, and stops it being carried into the building

**PRODUCTS:**  
Matting systems for indoor areas

DIRT INGRESS

**THE ADVANTAGES AT A GLANCE:**

- Substantial reduction of dirt ingress
- Clear decrease in cleaning costs
- Protection of high-quality adjoining floors
- Long-term preservation of the building's value

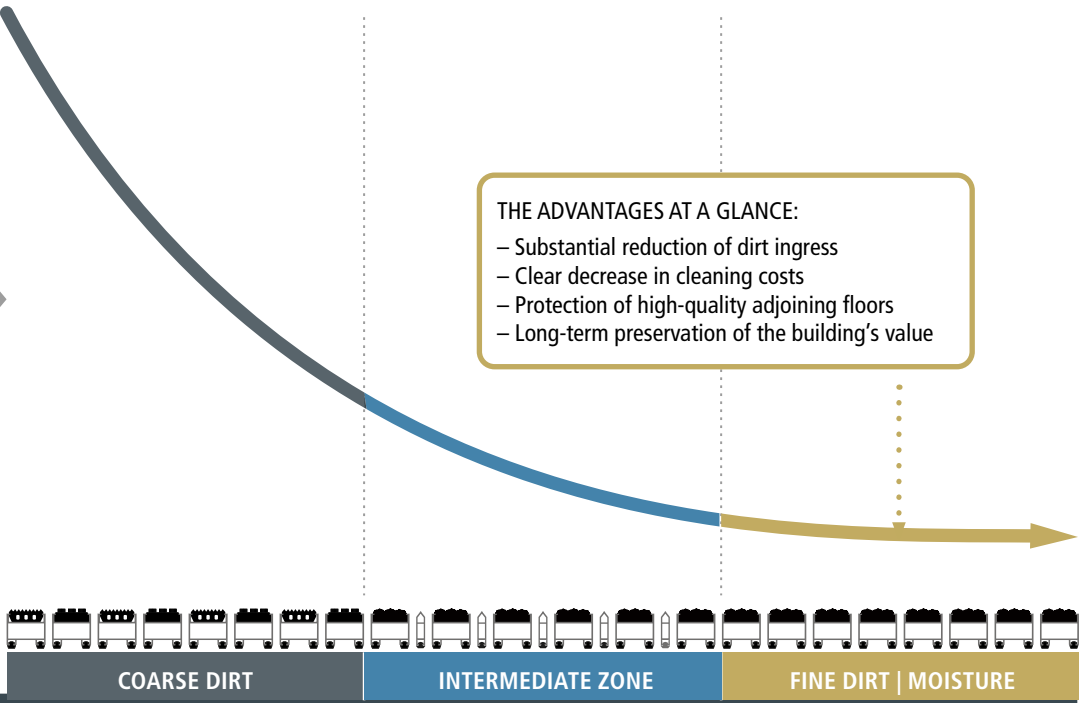

DIRT ABSORPTION	normal	medium	high
TOTAL MAT LENGTH (recommended)	3-5 m	6-7 m	8-10 m

# THE IDEAL LEVEL OF PROTECTION. IN EVERY AREA.

An entrance matting system is most effective if the profile, material and length are combined in the ideal way to meet requirements. This is the only way to achieve a lasting reduction in the quantities of dirt and moisture. And it is the only way to minimise the risk of slipping, protect adjoining floors, cut cleaning costs and preserve the value of the property. This is true not only for the entrance area, but also for many other doorways to a building. Simply everywhere where a substantial amount of dirt is to be found.

To achieve the optimum effect in every area, we develop and produce the appropriate system solution "Handmade in Germany": based on different installation heights and material strengths and a specially selected combination of materials.

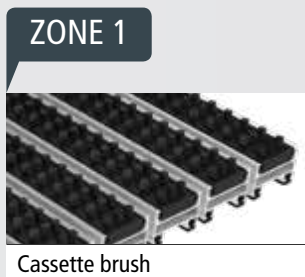



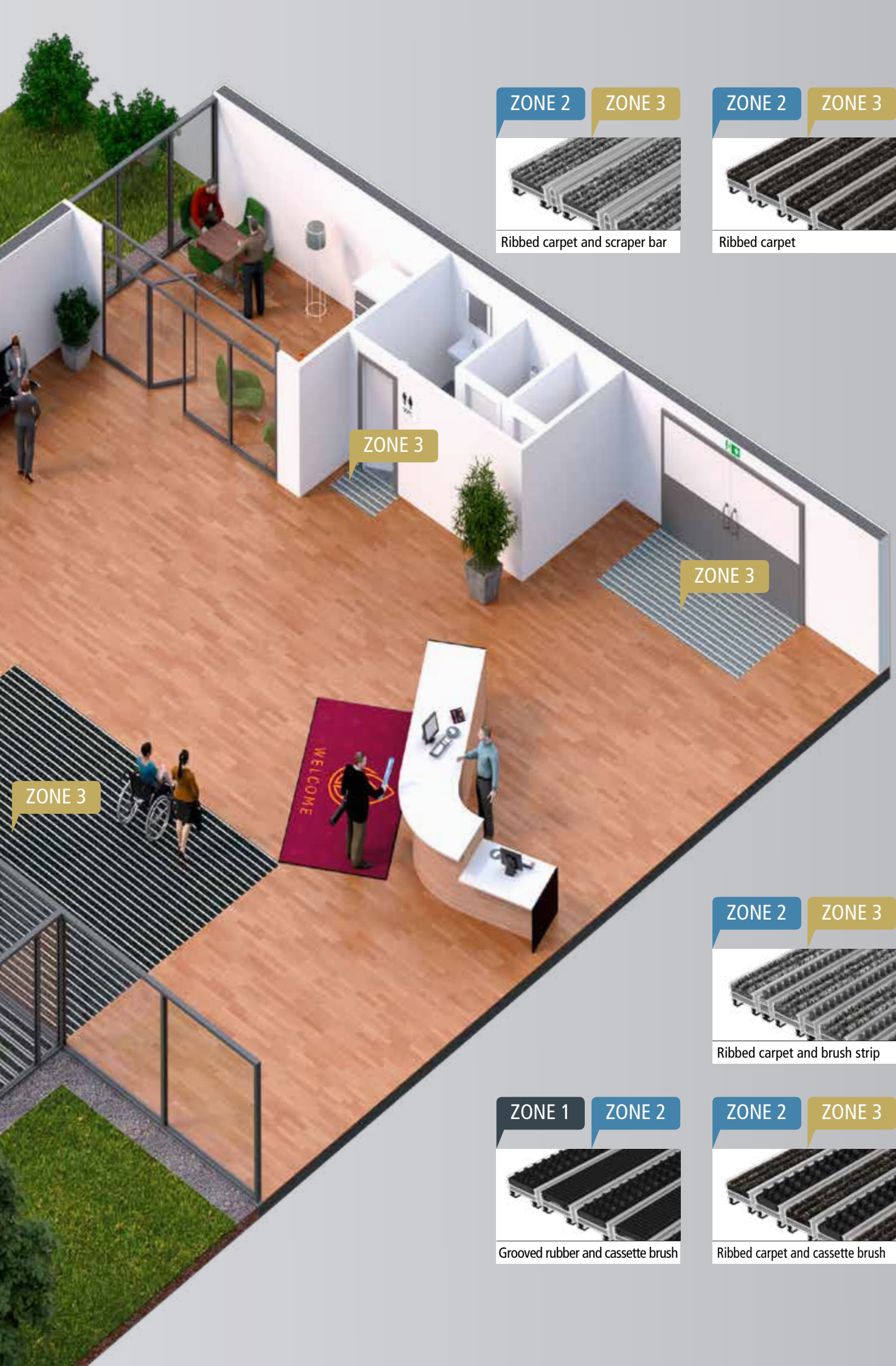

ZONE 2

ZONE 3

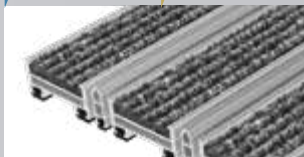

Ribbed carpet and scraper bar

ZONE 2

ZONE 3



Ribbed carpet

ZONE 3

ZONE 3

ZONE 3

ZONE 2

ZONE 3

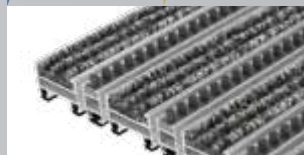

Ribbed carpet and brush strip

ZONE 1

ZONE 2



Grooved rubber and cassette brush

ZONE 2

ZONE 3



Ribbed carpet and cassette brush

## MAT HEIGHTS · LOAD







Entrance Matting Systems	mat height	Traffic <sup>1)</sup>	Permissible static load kg per 100 cm <sup>2</sup> of area		Load per wheel
			mat laid supported	mat laid self-supporting <sup>2)</sup>	
<b>Top Clean LIGHT XL 12</b>	ca. 12 mm	normal	7.000 kg	-	225 kg
<b>Top Clean TREND®</b>	ca. 12 mm	normal	6.000 kg	-	200 kg
<b>Top Clean STABIL</b>	ca. 12 mm	strong	8.000 kg	-	250 kg
<b>Top Clean TREND®</b>	ca. 17 mm	medium	5.000 kg	200 kg	210 kg
<b>Top Clean STABIL</b>	ca. 17 mm	strong	8.000 kg	250 kg	350 kg
<b>Top Clean TREND®</b>	ca. 22 mm	medium	5.000 kg	300 kg	220 kg
<b>Top Clean TREND® XL</b>	ca. 22 mm	medium	5.000 kg	300 kg	220 kg
<b>Top Clean STABIL</b>	ca. 22 mm	strong	8.000 kg	550 kg	450 kg
<b>Top Clean STABIL XL</b>	ca. 22 mm	strong	7.000 kg	550 kg	450 kg
<b>Top Clean OBJEKT</b>	ca. 22 mm	high	10.000 kg	600 kg	700 kg
<b>Top Clean TREND®</b>	ca. 27 mm	medium	5.000 kg	500 kg	220 kg
<b>Top Clean STABIL XL</b>	ca. 27 mm	strong	7.000 kg	550 kg	450 kg
<b>Top Clean HIGH</b>	ca. 42 mm	high	6.000 kg	800 kg	650 kg

1) Normal = up to 2,800 footfalls per day; heavy load = above 2,800; extremely heavy load = above 5,100.

2) Maximum distance between supports: 300 mm (carrying capacity has to be tested for safety when dirt collecting trays are installed).

3) Trafficability of mats with brush cassettes and scraper bars is limited. Avoid accelerating, braking, and manoeuvring on the mats!

# TRAFFIC

Entrance Matting Systems	A fully supported mat is suitable to drive over with permissible dynamic load <sup>3)</sup> :						
	 wheel chair	 luggage trolley	 shopping trolley	 transport trolley	 lift truck	 car	 fork lift truck
Top Clean LIGHT XL 12	■	■					
Top Clean TREND®	■	■					
Top Clean STABIL	■	■	■	■			
Top Clean TREND®	■	■	■	■			
Top Clean STABIL	■	■	■	■	■		
Top Clean TREND®	■	■	■	■	■		
Top Clean TREND® XL	■	■	■	■	■		
Top Clean STABIL	■	■	■	■	■	■	
Top Clean STABIL XL	■	■	■	■	■	■	
Top Clean OBJEKT	■	■	■	■	■	■	■
Top Clean TREND®	■	■	■	■	■	■	
Top Clean STABIL XL	■	■	■	■	■	■	
Top Clean HIGH	■	■	■	■	■	■	■

**Performance test at Bielefeld University of Applied Sciences:** The dynamic performance tests were executed at the independent Bielefeld University of Applied Sciences. The tests examined the performance of our aluminium mats by exposing them to different pressure ranges and driving over them with lift trucks.

**Performance test at the Department of Civil Engineering at Munich University of Applied Sciences:** A testing machine with a capacity of 100 t examined the static capacity of our mats with a 10x10 cm (=100 cm<sup>2</sup>) pressure hull. The test laboratory at Munich University has been approved by the German Center of Competence in Civil Engineering (DIBt).

## MAT HEIGHTS



## INLAYS / ADDITIONAL PROFILES

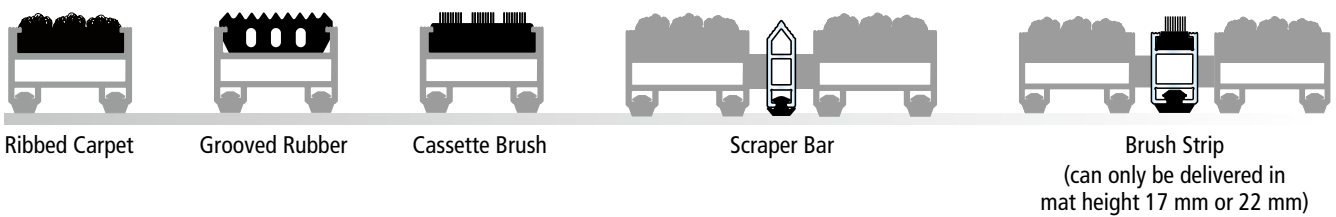

## AREAS OF USE

### Standard

For use in entrance areas with normal pedestrian traffic.



Top Clean TREND®



Top Clean LIGHT XL

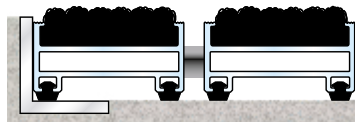

Top Clean TREND® XL

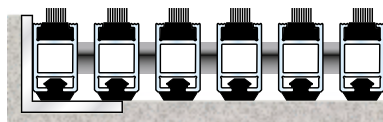

Top Clean BRUSH

### Heavy load

For use in entrance areas with heavy pedestrian traffic. Suitable for shopping trolleys in supermarkets or luggage trolleys in airports.

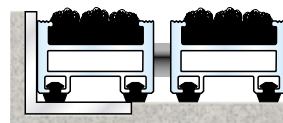

Top Clean STABIL

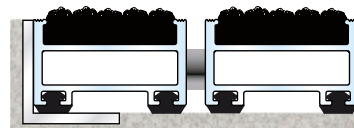

Top Clean STABIL XL

### Extreme load

For use in entrance areas with very high levels of pedestrian traffic. Shopping trolleys, pallet trucks or fork lift trucks may be used in these areas.

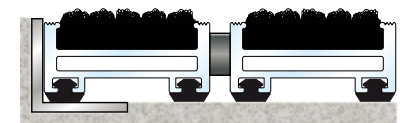

Top Clean OBJEKT

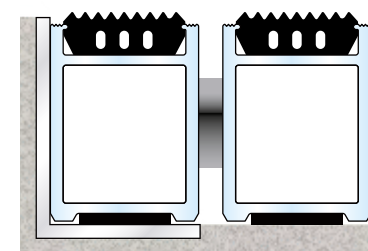

Top Clean HIGH

## TOP CLEAN MAT SYSTEMS PREVENT IMPACT SOUND

The slightest structure-borne sound on a floor can significantly increase the level of footfall noise. Even a small discontinuity in the insulation can generate notable impact sound. All Top Clean entrance area floor mats feature **continuous and highly effective acoustic insulation** to prevent footfall noise. Every component in our comprehensive range of systems comes with a sound-absorbing rubber profile.

We are setting new standards with the consistent further development of our tried and tested system solutions. The guaranteed acoustic insulation is now integrated into the scraper bars for the Top Clean system. **Thus, all combinations of brush strips, scraper bars, ribbed carpet and grooved rubber or cassette brushes are equipped with an effective system reducing footfall noise.** This is achieved by fitting an insulating rubber underlay to the profile. Thanks to its longevity and high sustainability, this technology is superior to foam material.

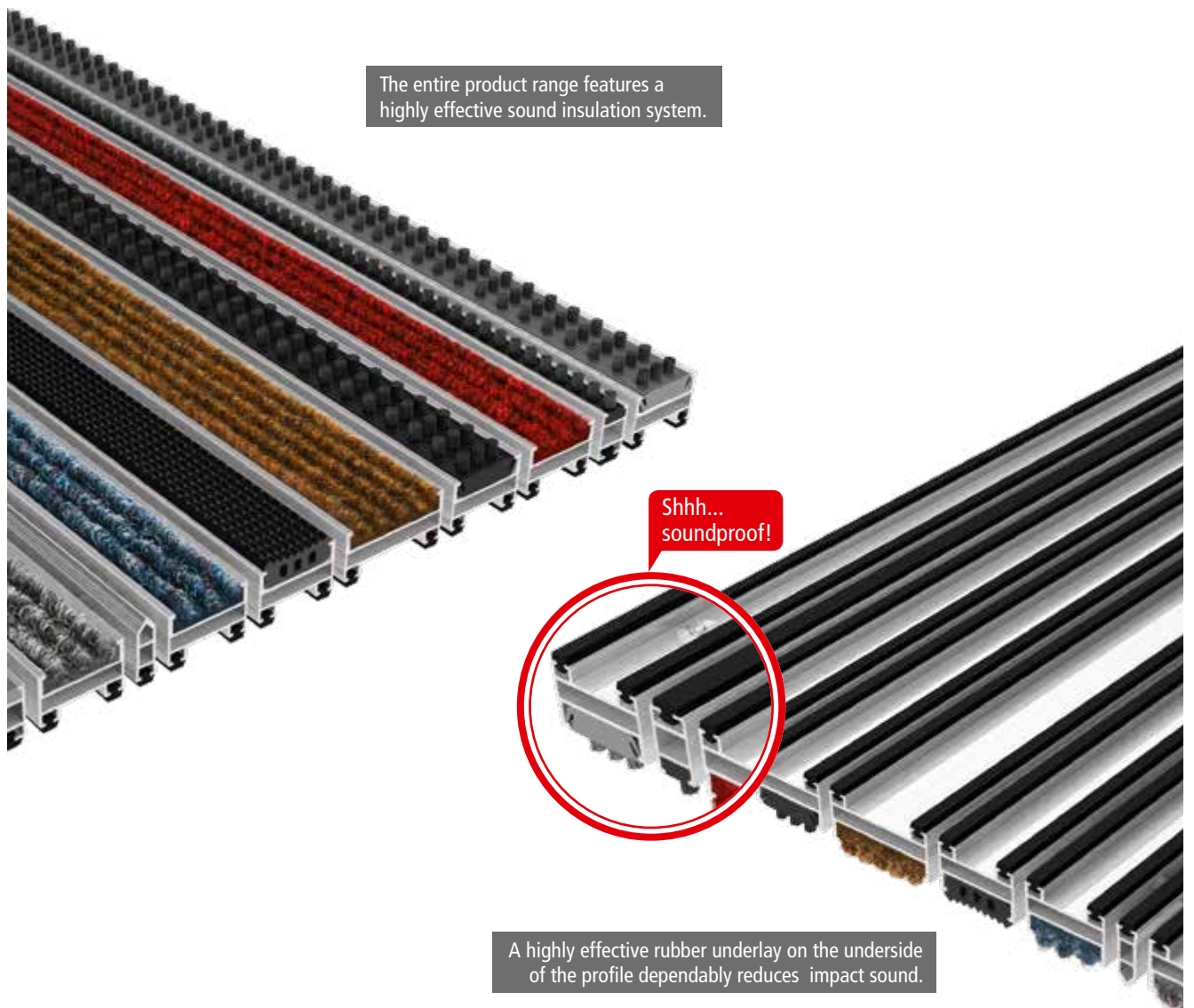

The entire product range features a highly effective sound insulation system.

Shhh...  
soundproof!

A highly effective rubber underlay on the underside of the profile dependably reduces impact sound.

## PLANNING FOR MATS, FRAMES AND DIRT COLLECTING TRAYS

- **Customer service:**  
Everything from one source... We offer our customers a flexible and mobile service for measuring and installation (digital measuring). Available upon request at extra charge
- **Mats for heavily frequented areas:**  
For entrance areas with heavy traffic (airports, supermarkets, shopping centres etc.) we recommend our aluminium profile mats Top Clean STABIL, Top Clean OBJEKT and Top Clean HIGH, which meet these special requirements (Indoor areas see pages 30-36; Outdoor areas see pages 44-50).
- **Optimum fitting:**  
A mat should always be in a frame that is fitted flush with the floor. Measuring and installation of the frame are described on page 67.
- **Laying mats without a frame:**  
The Top Clean TREND® mat in the 12 and 17-mm versions can be equipped with a ramped edge so that a well is not required for any subsequent relaying (see page 68).
- **When ordering a system:**  
that consists of a frame with mat or a well with mat, please indicate the outside dimensions of the frame (on page 16).
- **Existing angle frames:**  
If you already have an angle frame, please indicate the clear inside dimensions of the frame. We will deduct approx. 5 mm to calculate the production size for the mat (see also notes on laying tolerance on page 16).
- **Special designs:**  
For special designs (see page 18) we recommend a weather-resistant and durable PVC template.
- **When ordering, please remember:**  
For Top Clean mats for entrance areas, always indicate the profile length and the direction of traffic (see fax order form on page 16).
- **Drainage:**  
When installing angle frames or wells in outdoor areas, drainage should be provided so that water can drain away (e.g. by making an opening in the screed), or the mat well should be connected to the drainage system.
- **Multi-part mats:**  
For large-size entrance areas, mats with a profile length of more than 300 cm and/or a weight of more than 50 kg should be divided, as they will otherwise be too bulky or too heavy for installation and maintenance.

### 1. Dividing in the profile length

correct

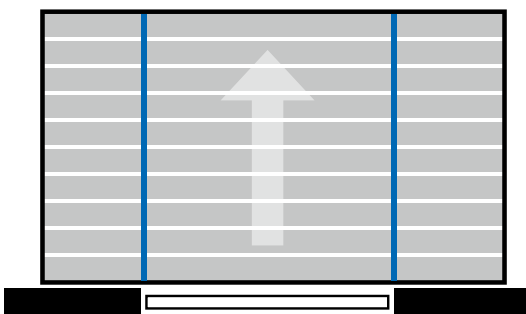

wrong

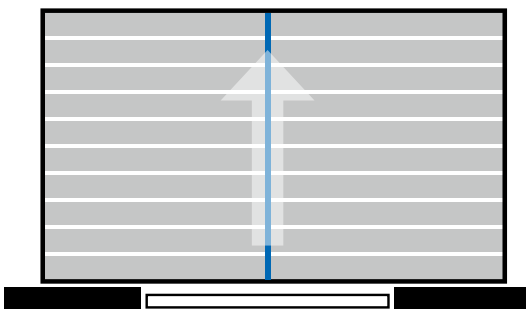

The main walking zones should not be divided in bar length.

### 2. Dividing in the walking direction

correct



Not recommended in porches.  
No division can be seen following installation.

## CONNECTORS FOR MULTI-PART MATS

When installing multi-part mats, single segments are connected via high-quality V2A steel sheet connectors. Our premium-class entrance mats are easy to install or dismantle thanks to this simple, proven connection method that prevents rifts between the mat parts.

In contrast to our competition, we do not just enclose connectors and have our customers install them, but pre-install connectors at our production site.

When mats are divided in profile length, connectors are fixated in a number of spots along the parting line hooked into fitting holes on the opposite side when installing the mat. This pre-installation ensures that all aluminium profiles are aligned with each other and do not shift. When walking on the mats, division lines are hardly recognizable.

When mats are divided in walking direction, the aluminium profiles may be hooked into the connectors installed opposite. Black spacers ensure correct interspace between profiles. The division lines of mats divided in walking direction are virtually invisible when walking on the mats. Thanks to our high-quality connection method, even large-size entrance mats appear to be of one piece!

**Connectors are permanently fixed, not enclosed uninstalled.**

connectors for profile length



connectors for walking direction

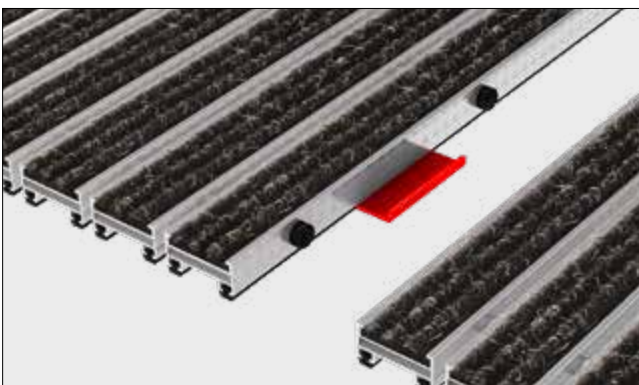

## INSERTION TOLERANCE / THERMAL EXPANSION DURING INSTALLATION

The standard expansion tolerance of our matting systems is 2.0 to 2.5 mm on all four sides; i.e. 4-5 mm are deducted from the internal frame dimension to the finished mat dimension in both directions (walking direction and profile length).

**Aluminium profiles may expand when exposed to heat. With large-size mats, the standard tolerance might be too small. When exposed to intense solar radiation, the mat might buckle in the frame or even warp where parts are connected if sufficient tolerance in the profile length is not provided.**

When installing large mats, please provide additional tolerance in the profile length according to the following table:

Profile length (Overall thickness, also valid for multi-part mats)	Tolerance in the profile length (Tolerance in walking direction remains 4 – 5 mm)
up to 6 m	4 mm – 5 mm
over 6 m - 10 m	6 mm – 7 mm
over 10 m	8 mm – 10 mm

If you submit frame dimensions only when ordering a matting system (frame and mat), we will calculate the required expansion tolerance according to the above table for you. The width of the frame will be added.

### Example: Matting system, external frame dimension 8 m profile length

external frame dimension	8.000 mm
minus frame width 2 x 3 mm	- 6 mm
minus tolerance 6-7 mm	- 7 mm
<b>results in a profile length of the mat</b>	<b>7.987 mm</b>

**Please note: When ordering a standard matting system (finished sizes), the purchaser is responsible for allowing sufficient expansion tolerance.**

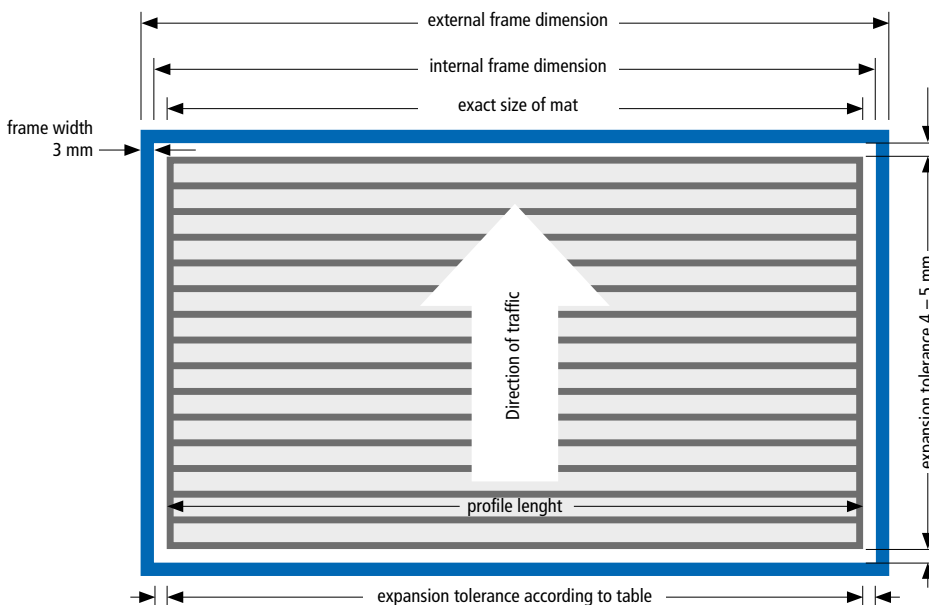



# CUSTOM-FIT TEMPLATES FOR SPECIAL MAT SHAPES

When ordering special designs with cut-outs, diagonal or curved shapes, templates might be required to manufacture the matting solution precisely according to your preferences. The most suitable material for producing templates accurately is rigid PVC sheeting. This weather-resistant material has a very high dimensional stability and is the best prerequisite for an exact fit of the mat. Please ensure that templates are rolled for transport, and never folded.

How to make a perfect template:

- Select a material that is dimensionally stable. The most suitable material is rigid PVC sheeting.
- The cut edges should be neatly finished.
- Do not indicate any additional measurements on the template.
- If a template turns out to be too small, you can simply enlarge it with parts cut to size by affixing them with adhesive tape.

### Please label the template as follows:

Please do label the upper surface and indicate the direction of traffic, the direction of the profiles and the dimensions. For multi-part mats, the division should also be indicated.

- 1) Label the upper side with "up".
- 2) Indicate the direction of traffic with an arrow.
- 3) Indicate the direction of the profiles.
- 4) Indicate the measurements as follows: external frame size = RAM  
internal frame size = RIM  
exact size of mat = MFM
- 5) Indicate divisions for multi-part mats – do not join sections together here.

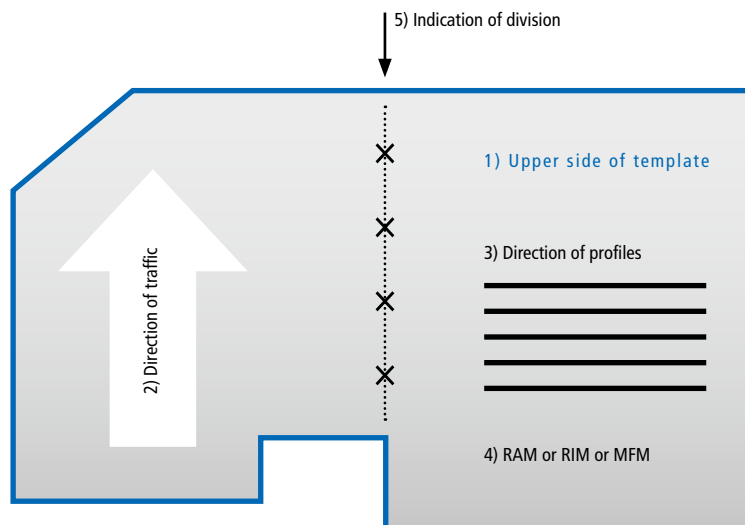

# SPECIAL SHAPES FRAMES AND MATTING

## Price Calculation for Circular Divided Entrance Mats and Frames

The red lines in the following drawings indicate the extra charge for the cutting of mats or frames. The prices of circular mats depend on how mats are divided. The mat area and the circumference of the curve will be calculated. These two positions form the basic price for the four variants of circular divided mats.

We are happy to make a detailed offer with drawing for custom-made variants. Please ask for our planning installation service.

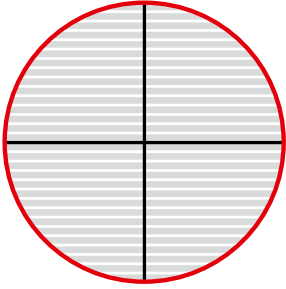
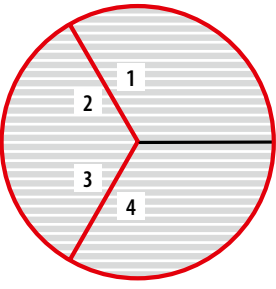
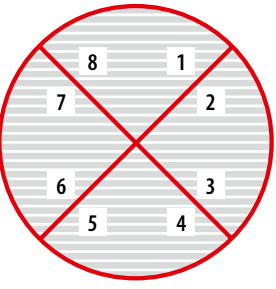
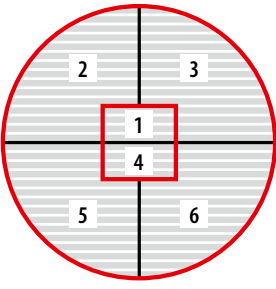
Typ 1: +- Dividing	Typ 2: Y-Dividing	Typ 3: X-Dividing	Typ 4: 6-Dividing
Extra charge only for circular cutting (highlighted in red)	Extra charge for circular cutting and four diagonal cuttings (highlighted in red)	Extra charge for circular cutting and eight diagonal cuttings (highlighted in red)	Extra charge for round cutting and gap (highlighted in red)
			

Extra costs will be added to the basic price.

## Price Calculation for Custom-Made Options with Gaps, Diagonal Cuts and Curves for Frames and Matting

The red lines in the following drawings indicate the extra charge for the cutting of mats or frames. We always charge the actual area and add the costs for the cutting versions a, b or c. Depending on the shape of the mat or frame to be produced, all three cutting options may be charged once or several times for calculating the price. We are happy to make a detailed offer with drawing for custom-made options. Please ask for our planning installation service (digital measurement).

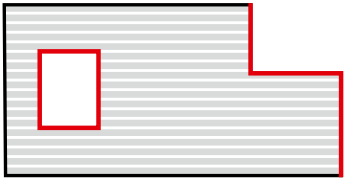
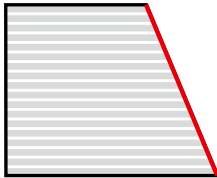
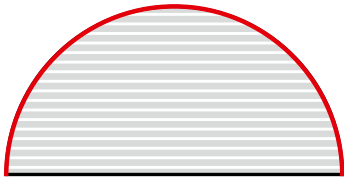
a) Gaps	b) Diagonal Cuts	c) Curves
Extra charge only for diagonal cut (highlighted in red)	Extra charge only for diagonal cut (highlighted in red)	Extra charge only for diagonal cut (highlighted in red)
		

Extra costs will be added to the basic price.

# CLEANING AND MAINTENANCE



High cleaning power and longevity are the outstanding features of our Matting Systems. To ensure the optimum performance of the mats, please read the following instructions for installation and care. Like any floor covering subject to heavy use, our Entrance Matting Systems benefit from a regular cleaning regime; the optimum frequency of cleaning depends on the specific traffic rate and the degree of soiling.

To ensure a long life-time of the mats, we recommend the following:

- ▶ **Regular Cleaning:** Clean the surface of the aluminium profile mat regularly with a vacuum cleaner. Set the vacuum cleaner to its highest setting.
- ▶ **Cleaning in the event of heavy soiling:** When heavily soiled, roll up the mat after vacuum cleaning and remove the dirt that has been collected in the frame.
- ▶ **Cleaning in the event of extreme soiling:** Extremely dirty matting can easily be cleaned with a high-pressure cleaner. After the cleaning process, put the mat in a vertical position for quick drying. Return dried mats into the mat well. Your entrance mat will be fully functional again.
- ▶ **Replacing single ribbed carpet strips:** Individual tread inserts can be replaced when heavily contaminated or damaged. New inserts can be fixed into existing aluminium profiles using double-sided adhesive tape. Customers can replace damaged inserts themselves.

## Replacement of Ribbed Carpet Strips

Bad soiling and objects such as cigarette butts and chewing gum as well as oil stains can severely impair the cleaning function of entrance mats. For this reason, we have developed a method for replacing badly soiled ribbed carpet strips. The used ribbed carpet strips are detached from the aluminium profile of the mat, so that residue and dirt can be removed from the base frame. A self-adhesive tape is attached to the back of the new ribbed carpet strip, which is then fixed in position.

### Recommended Sequence



1. Use a standard screwdriver to release the damaged insert from the aluminium profile and remove it.

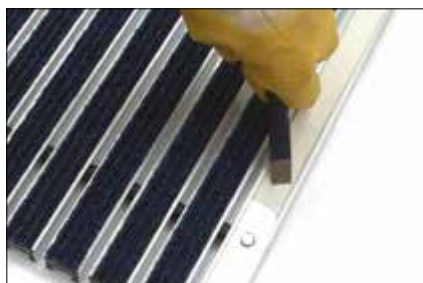

2. Please note: Dirt, ribbed carpet and glue must be removed from the aluminium profile (e.g. using a chisel).



3. Place new insert into the aluminium profile using self-adhesive tape; use a rubber hammer if necessary to affix insert.

## RIBBED CARPET COLOURS



010 Anthracite 1)  
Heavy Duty  
Ribbed Carpet 2)



020 Light Grey 1)  
Heavy Duty  
Ribbed Carpet



020 Dark Grey 1)  
Heavy Duty  
Ribbed Carpet



030 Mottled Beige 1)  
Heavy Duty  
Ribbed Carpet



040 Mottled Blue 1)  
Heavy Duty  
Ribbed Carpet



050 Green  
Heavy Duty  
Ribbed Carpet



060 Blue  
Heavy Duty  
Ribbed Carpet



070 Red 1)  
Heavy Duty  
Ribbed Carpet



080 Sand  
Heavy Duty  
Ribbed Carpet



090 Brown  
Heavy Duty  
Ribbed Carpet



100 Blue-Grey  
Heavy Duty  
Ribbed Carpet



110 Mauve  
Heavy Duty  
Ribbed Carpet



120 Blue-Violet  
Heavy Duty  
Ribbed Carpet



130 Black  
Heavy Duty  
Ribbed Carpet



140 Anthracite  
Heavy Duty  
Ribbed Carpet

1) For 12 mm mats with a fine ribbed structure

2) Also available as needle punch (100% polyamide) on request

Due to technical limitations colours are only approximate.

## RIBBED CARPET PROPERTIES



Total height: up to 11 mm



Application fields (DIN 66095): extreme



Slip resistant characteristics  
R11 to DIN 51130



Total weight: up to 3,000 g/m<sup>2</sup>



Rollable



Low-emission to RAL-ZU 128



Fibre: 100% Polypropylen



Heat conductive



Anti-Static < 2 kV



Material design: Cut-loop



Sound absorbing



Colour fastness  
against light ISO 105 B02: good 6



Pile weight: up to 1,700 g/m<sup>2</sup>



Fire rating to DIN EN 13501-1 (on request)



Colour fastness  
against friction ISO 105 X12: good



Backing: SBR-Latex impregnation



Suitable für wheel chairs



Colour fastness  
against water ISO 105 E01: good 5



Suitable for heavy traffic



Suitable for chair castor to DIN 54324

Technical changes and errors excepting.

## GROOVED RUBBER



210  
Grooved Rubber Black  
Fire behavior:  
Height 12 and 17 mm = Bfls1 (DIN EN 135011)  
Height 22 and 27 mm = Cfls1 (DIN EN 135011)

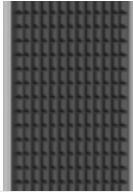

210  
Grooved Rubber Black  
Fire behavior:  
Height 22 and 27 mm = Cfl-s1 (DIN EN 13501-1)

## CASSETTE BRUSHES



310  
Cassette Brush  
3 brushes in row  
Black, 22 and 27 mm  
slip-resistant R13  
conforming DIN 51130  
(Bfl-s1 on request)



320  
Cassette Brush  
3 brushes in row  
Grey, 22 und 27 mm  
slip-resistant R13  
conforming DIN 51130

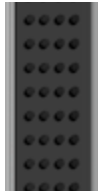

310  
Cassette Brush  
4 brushes in row  
Black, 12 und 17 mm  
slip-resistant R13  
conforming DIN 51130  
(Bfl-s1 on request)



320  
Cassette Brush  
4 brushes in row  
Grey, 12 und 17 mm  
slip-resistant R13  
conforming DIN 51130



310  
Cassette Brush XL  
4 brushes in row,  
Black, 22 und 27 mm  
slip-resistant R13  
conforming DIN 51130

## BRUSH STRIPS



410  
Brush Strip Black  
(Bfl-s1 on request)



420  
Brush Strip Grey



430  
Brush Strip Blue

Due to technical limitations colours are only approximate.



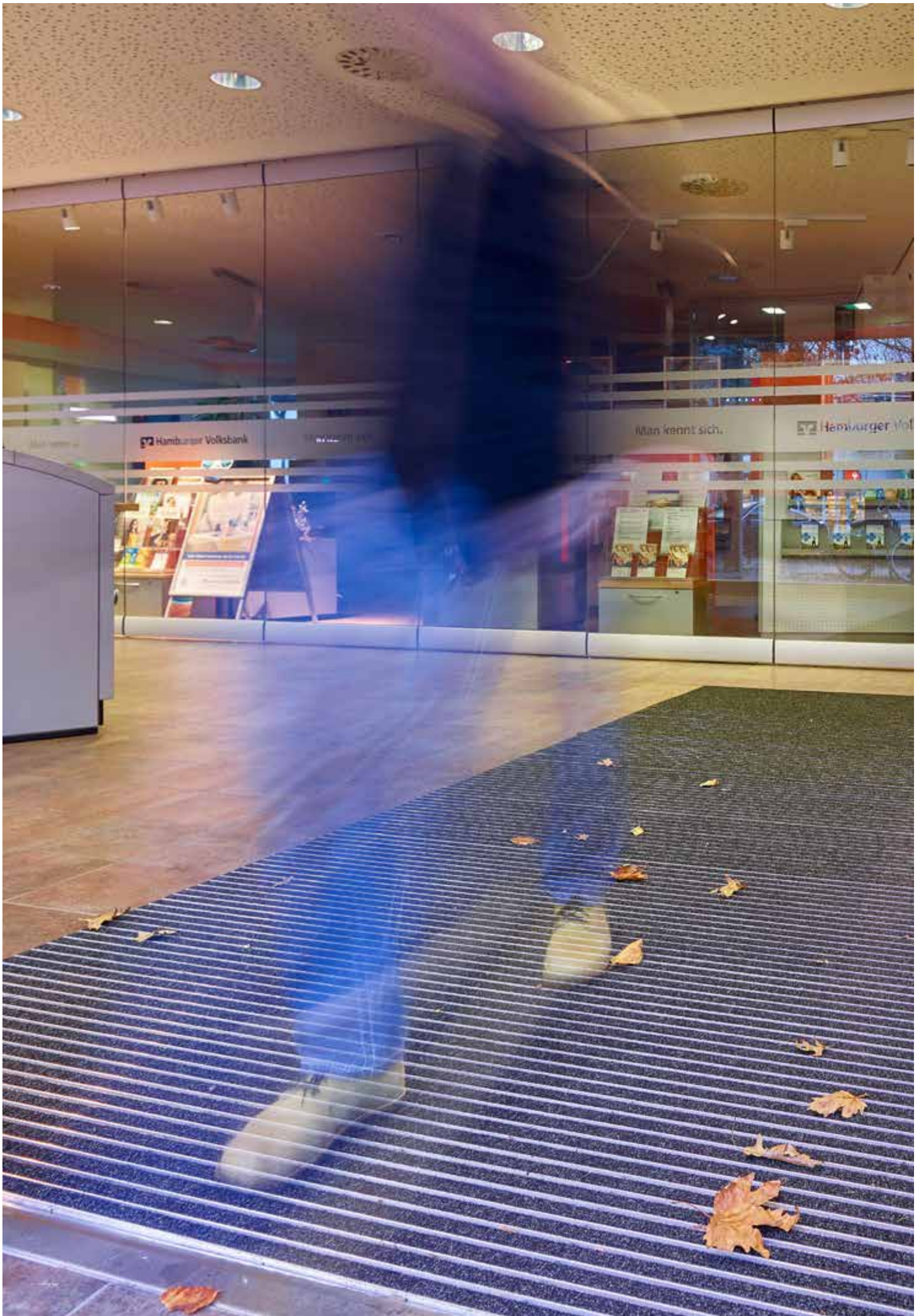



# 2

## MATTING SYSTEMS FOR INDOOR AREAS

### NORMAL TRAFFIC

- 24 TOP CLEAN TREND® XL GREEN MOTION  
WITH ECO-FRIENDLY RIBBED CARPET
- 25 TOP CLEAN LIGHT XL 12  
FOR INSTALLATION WITH LOW INSTALLATION HEIGHT
- 26 TOP CLEAN TREND® FOR NORMAL LOAD
- 28 TOP CLEAN TREND® XL FOR LARGE AREAS

### HIGH TRAFFIC | EXTREME TO HEAVY LOAD

- 30 TOP CLEAN STABIL FOR HEAVY USAGE
- 32 TOP CLEAN STABIL XL FOR HEAVY USAGE AND LARGE AREAS
- 34 TOP CLEAN OBJEKT FOR EXTREME HEAVY USAGE
- 36 TOP CLEAN HIGH FOR EXTREME USAGE AND HEAVY LOAD

# TOP CLEAN TREND® XL GREEN MOTION WITH ECO-FRIENDLY RIBBED CARPET



We place a major emphasis on sustainability in our products. One example is the eco-friendly GREEN MOTION variant within the Top Clean system. All components are 100% recyclable and can be returned for re-use – free of charge. The eco-anodized profile with ribbed carpet is corrosion-resistant, has sound insulation, is easy to clean and rollable. The GREEN MOTION system is available in any width and length; special shapes are available on request.

<b>Aluprofile</b>	Warp resistant aluminium profile (alloy EN AW 6060, wall thickness up to 1.5 mm), <b>eco-anodized E6/EV 1</b> , for fully supported installation. Outstanding corrosion resistance. <b>Completely recyclable.</b>
<b>Upper</b>	Ribbed carpet: unmixed, non-latex and durable polypropylene. UV-resistant. Slip-resistant properties R 11 conforming to <b>DIN 51130</b> (German Industrial Standard), fire-resistant Cfl-s1 conforming to <b>DIN EN 13501-1</b> (German Industrial Standard). <b>Completely recyclable.</b>
<b>Underside</b>	Non-PVC rubber profile with proven sound insulation for low-noise traffic. <b>Completely recyclable.</b>
<b>Connection</b>	Special threaded nipple with stainless steel screw (rust-proof). <b>Completely recyclable.</b>
<b>Lock</b>	Threaded nipple with stainless steel screw (rust-proof). <b>Completely recyclable.</b>
<b>Profile Spacing</b>	5 mm. Spacers are made of weather-resistant non-PVC rubber. <b>Completely recyclable.</b>

### Ribbed Carpet Colour



140  
Eco-friendly  
Ribbed carpet  
Anthracite

Due to technical limitations colours are only approximate.

With the "GREEN MOTION" ntrance mat, we are making a contribution to the increasingly important issue of environmental protection. The mat is completely PVC-free and all components are 100% recyclable. Returning the mat to the production cycle for recycling is free of charge..

### Top Clean TREND® XL GREEN MOTION with Eco-Friendly Ribbed Carpet

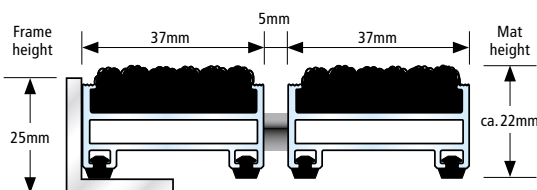

- For use indoors or in covered outdoor areas
- Accessible
- Recyclable
- Eco-anodized
- Rust-proof
- Non-PVC



All profiles feature highly effective impact sound insulation!



# TOP CLEAN LIGHT XL 12 FOR INSTALLATION WITH LOW INSTALLATION HEIGHT

This Top Clean version is particularly suitable for installation without mat frames because the mats have approximately the height of floor tiles. Top Clean LIGHT has been designed for use indoors and in covered outdoor areas with normal foot traffic. The robust ribbed carpet has a high cleaning power. Top Clean LIGHT features extra sound insulation due to the complete solid rubber profile underside. It has permanent, lifelong dimensions, is rollable and easy to clean. This version is only provided in a rectangular shape; no special shapes are available.

<b>Aluprofile</b>	Warp resistant aluminium profile (alloy EN AW 6060) for fully supported installation.
<b>Upper</b>	Ribbed carpet: UV-resistant, heavy-duty polypropylene, slip resistance properties R 11 conforming to <b>DIN 51130</b> (German Industrial Standard), fire behavior Cfl-s1 conforming <b>DIN EN 13501-1</b> (German Industrial Standard).
<b>Underside</b>	Base of the mat is mechanically fitted with rubber inserts for slip resistance and extreme noise reduction.
<b>Connection</b>	Flexible, pierced connection profile.
<b>Colours Compensation Profile</b>	Black or Grey.
<b>Profile Spacing</b>	5 mm.
<b>Dimensions</b>	When laying the mat inside of an existing mat frame, the front to back dimension is reached using a compensation profile (grey or black) when needed. When laying freely, the walking direction is an approximate measure (a little smaller or larger). Only rectangular mats are available for Top Clean LIGHT; no gaps, curves or diagonal cutting.
<b>Profile Colours</b>	Natural aluminium. Profile can be supplied powder-coated to any RAL colour (for an extra charge).

Standard Colours - Special Colour options page 20

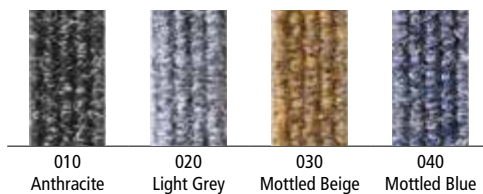

Due to technical limitations colours are only approximate.

## Top Clean TREND LIGHT with Ribbed Carpet

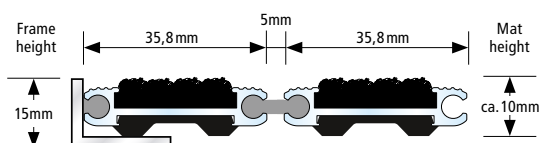

- For use indoors or in covered outdoor areas
- Recyclable
- Rust-proof



All profiles feature highly effective impact sound insulation!



# TOP CLEAN TREND® FOR NORMAL LOAD

Ribbed carpet is a durable, moisture-absorbing material. Brush Strips and cassette brushes effectively protect high-quality floors against damage. Brushes with superior cleaning power remove foot-borne dirt like sand and grit, which is collected in the mat frame. Scraper Bars installed between the profiles increase the cleaning effect even more. Sound-absorbing, dimensionally stable, rollable and easy to clean. Available in any width and length. Special shapes at extra charge.

<b>Aluprofile</b>	Warp resistant aluminium profile (alloy EN AW 6060, wall thickness up to 1.5 mm) for fully supported installation.
<b>Upper/Combinations</b>	You may choose between various installation options or even combine several options: <ul style="list-style-type: none"> <li>• Ribbed Carpet: UV-resistant heavy-duty polypropylene, slip-resistant properties R 11 conforming to <a href="#">DIN 51130</a> (German Industrial Standard).</li> <li>• Scraper Bars made of warp resistant aluminium profile.</li> <li>• Brush Strips made of robust polyamide 6.</li> <li>• Cassette Brush made of robust, heavy-duty polyamide 6, slip-resistant properties R 13 conforming to <a href="#">DIN 51130</a> (German Industrial Standard).</li> </ul>
<b>Underside</b>	Base of the mat is mechanically fitted with rubber inserts for anti-slip and noise reduction.
<b>Connection</b>	Stainless steel wire rope V2A for Ø 2 mm for 12, and 17 mm mat height, Coated galvanized wire rope for 22 and 27 mm mat height.
<b>Lock</b>	Special threaded nipple with stainless steel screw (rust-proof).
<b>Profile Spacing</b>	5 mm. Profile spacing optional also in 3 mm for automatic door systems conforming to <a href="#">DIN 18650</a> . Flexible spacers made of rubber.
<b>Profile Colours</b>	Natural aluminium. Profile can be supplied powder-coated to any RAL colour (for an extra charge).

### Standard Colours · Special Colour options page 20

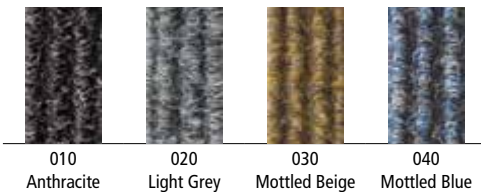

### Cassette Brush

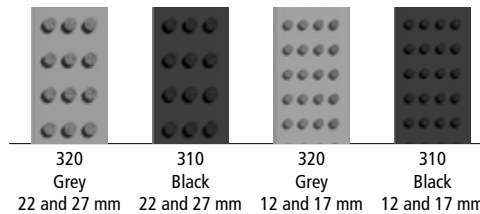

### Brush Strip

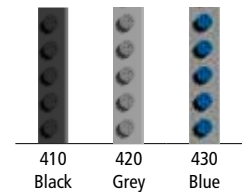

Due to technical limitations colours are only approximate.



# TOP CLEAN TREND® POSSIBLE COMBINATIONS

## Top Clean TREND® with Ribbed Carpet

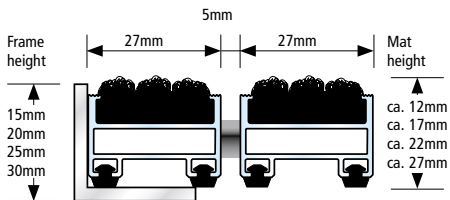

- For use indoors or in covered outdoor areas
- Accessible
- Recyclable
- Rust-proof



## Top Clean TREND® with Ribbed Carpet and Scraper Bar

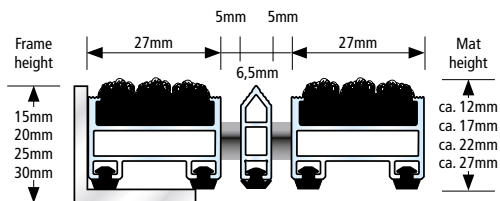

- For use indoors or in covered outdoor areas
- Accessible
- Recyclable
- Rust-proof



## Top Clean TREND® with Ribbed Carpet and Brush Strip

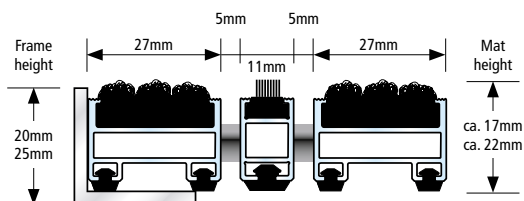

- For use indoors or in covered outdoor areas
- Accessible
- Recyclable
- Rust-proof

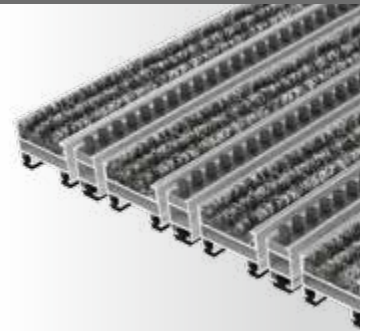

## Top Clean TREND® with Ribbed Carpet and Cassette Brush

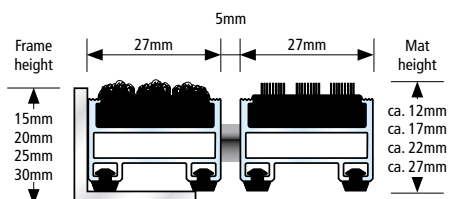

- For use indoors or in covered outdoor areas
- Recyclable
- Rust-proof



All profiles feature highly effective impact sound insulation!



# TOP CLEAN TREND® XL FOR LARGE AREAS

Continuously enhancing the Top Clean TREND® series, we now provide this version with broad aluminium profiles. It is best applicable in large-sized, architecturally ambitious entrance areas. Ribbed carpet elements with 37 mm width and cassette brushes provide optimal dirt collection and walking comfort. Individual combinations of scraper bars and brush strips with high cleaning power may be added. Sound-absorbing, dimensionally stable, rollable and easy to clean. Available in any width and length. Special shapes at extra charge.

<b>Aluprofile</b>	Warp resistant aluminium profile (alloy EN AW 6060, wall thickness up to 1.5 mm) for fully supported installation.
<b>Upper/ Combinations</b>	You may choose between various installation options or even combine several options: <ul style="list-style-type: none"> <li>• Ribbed Carpet: UV-resistant heavy-duty polypropylene, slip-resistant properties R 11 conforming to <a href="#">DIN 51130</a> (German Industrial Standard).</li> <li>• Scraper Bars made of warp resistant aluminium profile.</li> <li>• Brush Strips made of robust polyamide 6.</li> <li>• Cassette Brush made of robust, heavy-duty polyamide 6, slip-resistant properties R 13 conforming to <a href="#">DIN 51130</a> (German Industrial Standard).</li> </ul>
<b>Underside</b>	Base of the mat is mechanically fitted with rubber inserts for anti-slip and noise reduction.
<b>Connection</b>	Coated galvanized wire rope.
<b>Lock</b>	Special threaded nipple with stainless steel screw (rust-proof).
<b>Profile Spacing</b>	5 mm. Flexible spacers made of rubber.
<b>Profile Colours</b>	Natural aluminium. Profile can be supplied powder-coated to any RAL colour (for an extra charge).

### Standard Colours · Special Colour options page 20

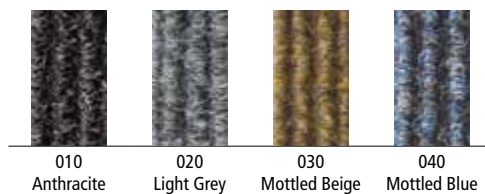

### Cassette Brush

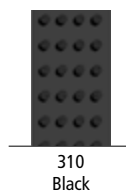

### Brush Strip

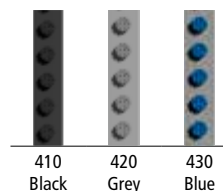

Due to technical limitations colours are only approximate.



# TOP CLEAN TREND® XL POSSIBLE COMBINATIONS

## Top Clean TREND® XL with Ribbed Carpet

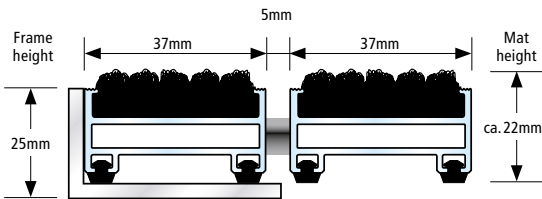

- For use indoors or in covered outdoor areas
- Accessible
- Recyclable
- Rust-proof



## Top Clean TREND® XL with Ribbed Carpet and Scraper Bar

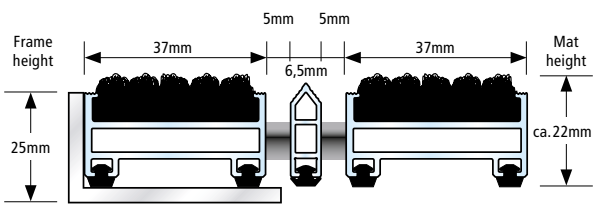

- For use indoors or in covered outdoor areas
- Accessible
- Recyclable
- Rust-proof



## Top Clean TREND® XL with Ribbed Carpet and Brush Strip

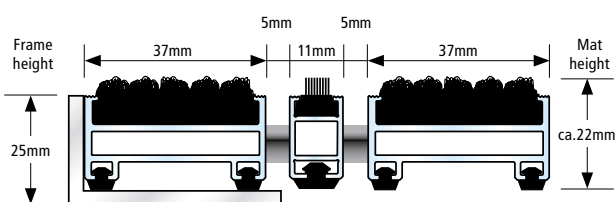

- For use indoors or in covered outdoor areas
- Accessible
- Recyclable
- Rust-proof



## Top Clean TREND® XL with Ribbed Carpet and Cassette Brush

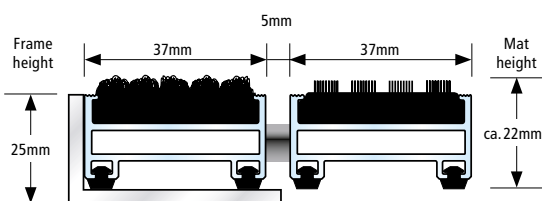

- For use indoors or in covered outdoor areas
- Recyclable
- Rust-proof



All profiles feature highly effective impact sound insulation!



# TOP CLEAN STABIL FOR HEAVY USAGE

This multi-variant cleaning system is the heavy-duty version of Top Clean TREND®. The STABIL variant is predestined for use in entrance areas with heavy traffic and load. Suitable for lift trucks and transport trolleys. This version is highly efficient thanks to a range of available combinations of ribbed carpet, cassette brushes and scraper bars. It is also available in 12 mm height. Sound-absorbing, dimensionally stable, rollable and easy to clean. Available in any width and length. Special shapes at extra charge.

<b>Aluprofile</b>	Warp resistant aluminium profile (alloy EN AW 6060-6063, wall thickness up to 2.5 mm) for fully supported and self-supporting installation (substructure on site, maximum distance between supports 300 mm).
<b>Upper/ Combinations</b>	You may choose between various installation options or even combine several options: <ul style="list-style-type: none"> <li>• Ribbed Carpet: UV-resistant heavy-duty polypropylene, slip-resistant properties R 11 conforming to <a href="#">DIN 51130</a> (German Industrial Standard).</li> <li>• Anti-slip Grooved Rubber (EPDM), with lengthwise and crosswise grooves, heavy-duty and UV-resistant conforming to <a href="#">DIN 7863</a> (German Industrial Standard), fire behavior for mat heights 12 mm and 17 mm = Bfl-s1, for mat height 22 mm = Cfl-s1 conforming <a href="#">DIN EN 13501-1</a> (German Industrial Standard).</li> <li>• Scraper Bars made of warp resistant aluminium profile.</li> <li>• Cassette Brush made of robust, heavy-duty polyamide 6, slip-resistant properties R 13 conforming to <a href="#">DIN 51130</a> (German Industrial Standard).</li> </ul>
<b>Underside</b>	Base of the mat is mechanically fitted with rubber inserts for anti-slip and noise reduction.
<b>Connection</b>	Stainless steel wire rope V2A Ø 2 mm for 12 and 17 mm mat height, Stainless steel wire rope V2A Ø 3 for 22 mm mat height..
<b>Lock</b>	Special threaded nipple with stainless steel screw (rust-proof).
<b>Profile Spacing</b>	5 mm. Profile spacing optional also in 3 mm for automatic door systems conforming to <a href="#">DIN 18650</a> . Flexible spacers made of rubber.
<b>Profile Colours</b>	Natural aluminium. Profile can be supplied powder-coated to any RAL colour (for an extra charge).

### Standard Colours · Special Colour options page 20

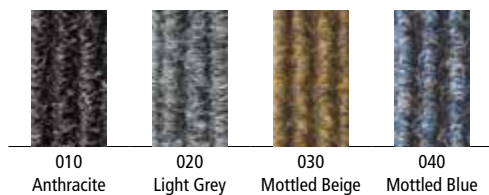

### Cassette Brush

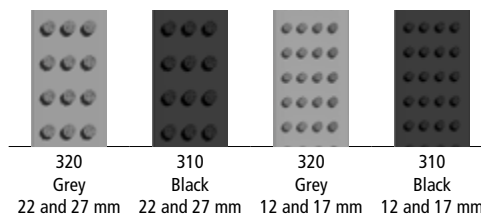

### Grooved Rubber

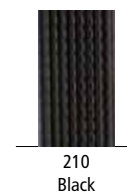

Due to technical limitations colours are only approximate.

# TOP CLEAN STABIL POSSIBLE COMBINATIONS

## Top Clean STABIL with Ribbed Carpet

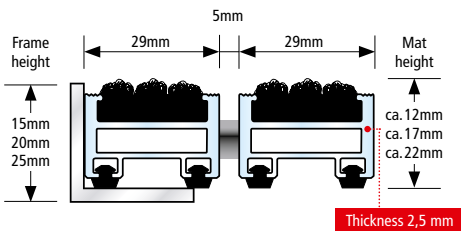

- For use indoors or in covered outdoor areas
- Accessible
- Accessible with hand lift truck
- Recyclable
- Rust-proof

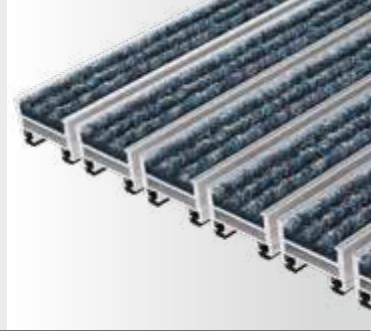

## Top Clean STABIL with Ribbed Carpet and Grooved Rubber

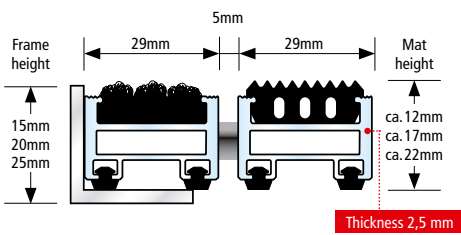

- For use indoors or in covered outdoor areas
- Accessible
- Accessible with hand lift truck
- Recyclable
- Rust-proof



## Top Clean STABIL with Ribbed Carpet and Scraper Bar

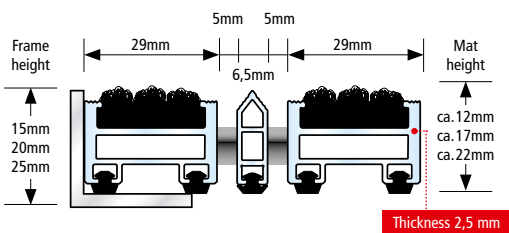

- For use indoors or in covered outdoor areas
- Accessible
- Accessible with hand lift truck
- Recyclable
- Rust-proof

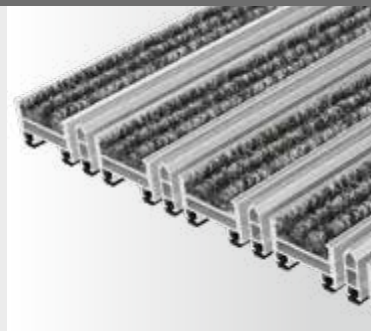

## Top Clean STABIL with Ribbed Carpet and Cassette Brush

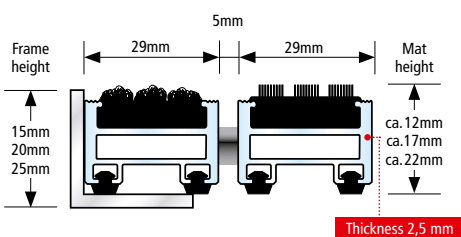

- For use indoors or in covered outdoor areas
- Accessible with hand lift truck
- Recyclable
- Rust-proof



All profiles feature highly effective impact sound insulation!



# TOP CLEAN STABIL XL FOR HEAVY USAGE AND LARGE AREAS

This new Top Clean STABIL version is a very durable and efficient solution with long-term dimensional stability and 39 mm-wide profiles. It has been designed for large, spacious entrance areas. The system provides combinations in various heights for high pedestrian traffic. Options include ribbed carpet in a great variety of colours as well as cassette brushes and scraper bars. Suitable for lift trucks and transport trolleys. Sound-absorbing, dimensionally stable, rollable and easy to clean. Available in any width and length. Special shapes at extra charge.

<b>Aluprofile</b>	Warp resistant aluminium profile (alloy EN AW 6060, wall thickness up to 2.5 mm) for fully supported and self-supporting installation (substructure on site, maximum distance between supports 300 mm).
<b>Upper/Combinations</b>	You may choose between various installation options or even combine several options: <ul style="list-style-type: none"> <li>• Ribbed Carpet: UV-resistant heavy-duty polypropylene, slip-resistant properties R 11 conforming to <b>DIN 51130</b> (German Industrial Standard).</li> <li>• Anti-slip Grooved Rubber (EPDM), with lengthwise and crosswise grooves, heavy-duty and UV-resistant conforming to <b>DIN 7863</b> (German Industrial Standard), fire behavior Cfl-s1 conforming <b>DIN EN 13501-1</b> (German Industrial Standard).</li> <li>• Scraper Bars made of warp resistant aluminium profile.</li> <li>• Cassette Brush made of robust, heavy-duty polyamide 6, slip-resistant properties R 13 conforming to <b>DIN 51130</b> (German Industrial Standard).</li> </ul>
<b>Underside</b>	Base of the mat is mechanically fitted with rubber inserts for anti-slip and noise reduction.
<b>Connection</b>	Stainless steel wire rope V2A for Ø 3 for 22 and 27 mm mat height.
<b>Lock</b>	Special threaded nipple with stainless steel screw (rust-proof).
<b>Profile Spacing</b>	5 mm. Flexible spacers made of rubber.
<b>Profile Colours</b>	Natural aluminium. Profile can be supplied powder-coated to any RAL colour (for an extra charge).

### Standard Colours · Special Colour options page 20

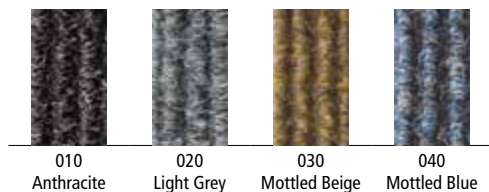

### Cassette Brush

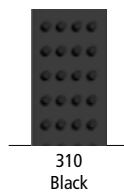

### Grooved Rubber

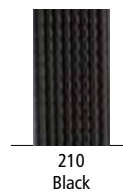

Due to technical limitations colours are only approximate.



# TOP CLEAN STABIL XL POSSIBLE COMBINATIONS

## Top Clean STABIL XL with Ribbed Carpet

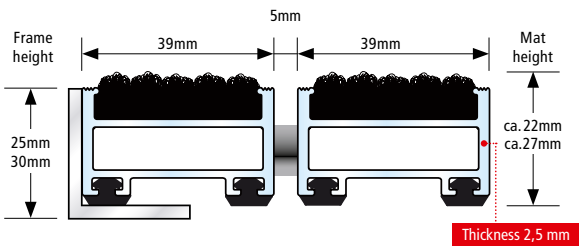

- For use indoors or in covered outdoor areas
- Accessible
- Accessible with hand lift truck
- Recyclable
- Rust-proof



## Top Clean STABIL XL with Ribbed Carpet and Grooved Rubber

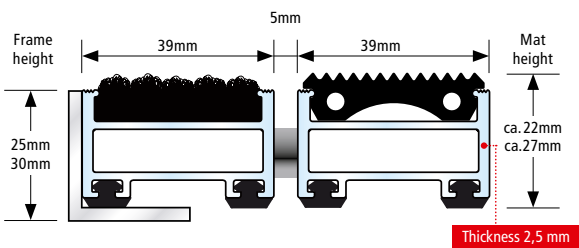

- For use indoors or in covered outdoor areas
- Accessible
- Accessible with hand lift truck
- Recyclable
- Rust-proof



## Top Clean STABIL XL with Ribbed Carpet and Scraper Bar

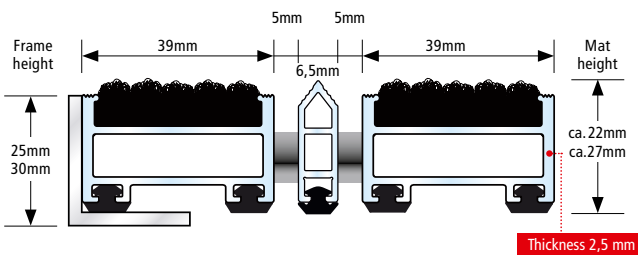

- For use indoors or in covered outdoor areas
- Accessible
- Accessible with hand lift truck
- Recyclable
- Rust-proof

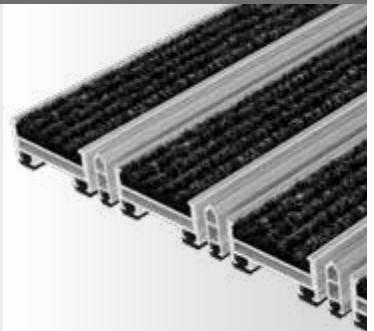

## Top Clean STABIL XL with Ribbed Carpet and Cassette Brush

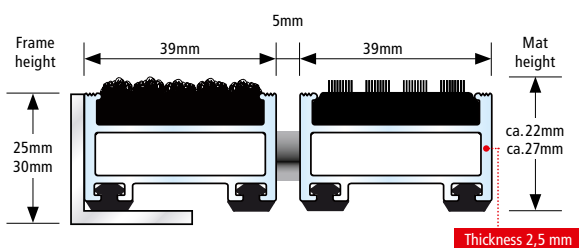

- For use indoors or in covered outdoor areas
- Accessible with hand lift truck
- Recyclable
- Rust-proof



All profiles feature highly effective impact sound insulation!



# TOP CLEAN OBJEKT FOR EXTREME HEAVY USAGE

Top Clean OBJEKT has been designed for entrance areas with very heavy pedestrian and trolley traffic. We recommend this version for shopping malls, airports and stations. Extremely robust, durable 40-mm profiles allow for hand lift truck, forklift and transport trolley traffic on the mat. Durable ribbed carpet and robust cassette brushes provide a strong cleaning performance. Sound-absorbing, dimensionally stable, rollable and easy to clean. Available in any width and length. Special shapes at extra charge.

<b>Aluprofile</b>	Warp resistant aluminium profile (alloy EN AW 6060, wall thickness up to 3.0 mm) for fully supported and self-supporting installation (substructure on site, maximum distance between supports 300 mm).
<b>Upper/Combinations</b>	You may choose between various installation options or even combine several options: <ul style="list-style-type: none"> <li>• Ribbed Carpet: UV-resistant heavy-duty polypropylene, slip-resistant properties R 11 conforming to <a href="#">DIN 51130</a> (German Industrial Standard).</li> <li>• Anti-slip Grooved Rubber (EPDM), with lengthwise and crosswise grooves, heavy-duty and UV-resistant conforming to <a href="#">DIN 7863</a> (German Industrial Standard), fire behavior Cfl-s1 conforming <a href="#">DIN EN 13501-1</a> (German Industrial Standard).</li> <li>• Cassette Brush made of robust, heavy-duty polyamide 6, slip-resistant properties R 13 conforming to <a href="#">DIN 51130</a> (German Industrial Standard).</li> </ul>
<b>Underside</b>	Base of the mat is mechanically fitted with rubber inserts for anti-slip and noise reduction.
<b>Connection</b>	Stainless steel wire rope V2A for Ø 3 mm.
<b>Lock</b>	Special threaded nipple with stainless steel screw (rust-proof).
<b>Profile Spacing</b>	5 mm. Flexible spacers made of rubber.
<b>Profile Colours</b>	Natural aluminium. Profile can be supplied powder-coated to any RAL colour (for an extra charge).

### Standard Colours · Special Colour options page 20



010  
Anthracite



020  
Light Grey



030  
Mottled Beige



040  
Mottled Blue

### Cassette Brush



310  
Black

### Grooved Rubber



210  
Black

Due to technical limitations colours are only approximate.

# TOP CLEAN OBJEKT POSSIBLE COMBINATIONS

## Top Clean OBJEKT with Ribbed Carpet

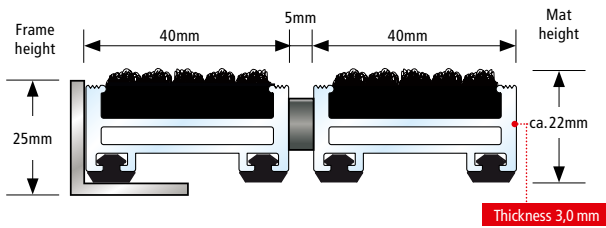

- For use indoors or in covered outdoor areas
- Accessible
- Accessible with hand lift truck
- Accessible with forklift truck
- Recyclable
- Rust-proof



## Top Clean OBJEKT with Ribbed Carpet and Grooved Rubber

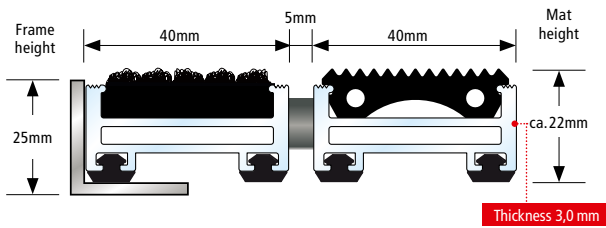

- For use indoors or in covered outdoor areas
- Accessible
- Accessible with hand lift truck
- Accessible with forklift truck
- Recyclable
- Rust-proof



## Top Clean OBJEKT with Ribbed Carpet and Cassette Brush

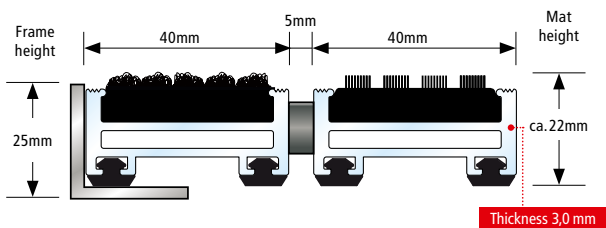

- For use indoors or in covered outdoor areas
- Accessible with hand lift truck
- Accessible with forklift truck
- Recyclable
- Rust-proof



All profiles feature highly effective impact sound insulation!



# TOP CLEAN HIGH FOR EXTREME USAGE AND HEAVY LOAD

Performance tests by independent institutes have confirmed the outstanding quality of the Top Clean HIGH version – continuously laid mats can carry loads of up to 6,000 kg. Robust frames and mats with 42 mm height ensure this system's longevity, even in areas with extreme traffic. Top Clean HIGH mats feature ribbed carpet and cassette brushes with superior cleaning performance. Sound-absorbing, dimensionally stable, rollable and easy to clean. Available in any width and length. Special shapes at extra charge.

<b>Aluprofile</b>	Warp resistant aluminium profile (alloy EN AW 6060, wall thickness up to 2.5 mm) for fully supported and self-supporting installation (substructure on site, maximum distance between supports 300 mm).
<b>Upper/ Combinations</b>	You may choose between various installation options or even combine several options: <ul style="list-style-type: none"> <li>• Ribbed Carpet: UV-resistant heavy-duty polypropylene, slip-resistant properties R 11 conforming to <a href="#">DIN 51130</a> (German Industrial Standard).</li> <li>• Anti-slip Grooved Rubber (EPDM), with lengthwise and crosswise grooves, heavy-duty and UV-resistant conforming to <a href="#">DIN 7863</a> (German Industrial Standard), fire behavior Cfl-s1 conforming <a href="#">DIN EN 13501-1</a> (German Industrial Standard).</li> <li>• Cassette Brush made of robust, heavy-duty polyamide 6, slip-resistant properties R 13 conforming to <a href="#">DIN 51130</a> (German Industrial Standard).</li> </ul>
<b>Underside</b>	Slip resistance and noise reduction achieved by bonded PE-foam.
<b>Connection</b>	Stainless steel wire rope V2A for Ø 3 mm.
<b>Lock</b>	Special threaded nipple with stainless steel screw (rust-proof).
<b>Profile Spacing</b>	5 mm. Flexible spacers made of rubber.
<b>Profile Colours</b>	Natural aluminium. Profile can be supplied powder-coated to any RAL colour (for an extra charge).

### Standard Colours · Special Colour options page 20



010  
Anthracite



020  
Light Grey



030  
Mottled Beige



040  
Mottled Blue

### Cassette Brush



320  
Grey



310  
Black

### Grooved Rubber



210  
Black

Due to technical limitations colours are only approximate.

# TOP CLEAN HIGH POSSIBLE COMBINATIONS

## Top Clean HIGH with Ribbed Carpet

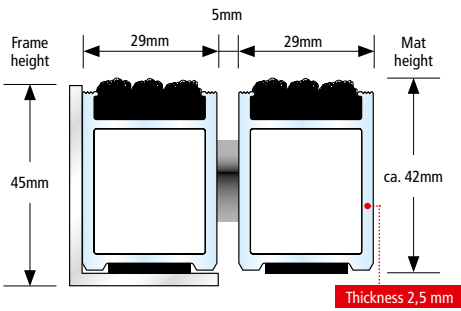

- For use indoors or in covered outdoor areas
- Accessible
- Accessible with hand lift truck
- Accessible with forklift truck
- Recyclable
- Rust-proof

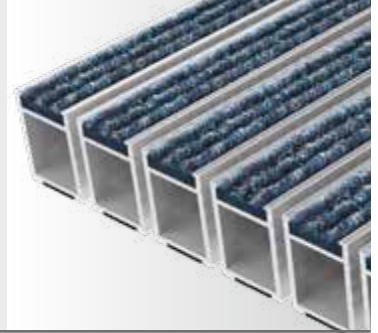

## Top Clean HIGH with Ribbed Carpet and Grooved Rubber

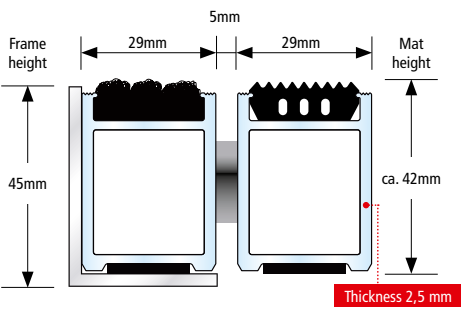

- For use indoors or in covered outdoor areas
- Accessible
- Accessible with hand lift truck
- Accessible with forklift truck
- Recyclable
- Rust-proof

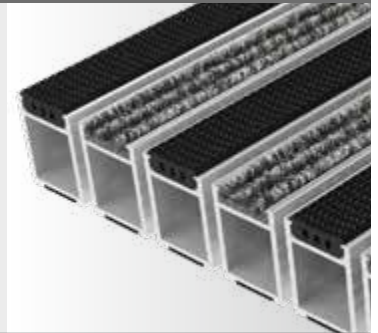

## Top Clean HIGH with Ribbed Carpet and Cassette Brush

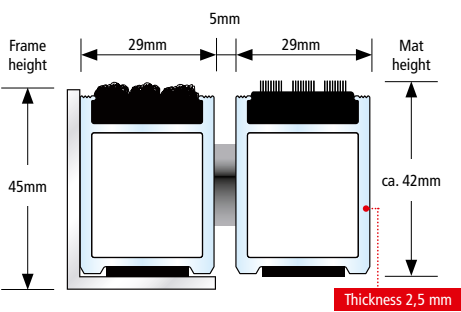

- For use indoors or in covered outdoor areas
- Accessible with hand lift truck
- Accessible with forklift truck
- Recyclable
- Rust-proof



All profiles feature highly effective impact sound insulation!



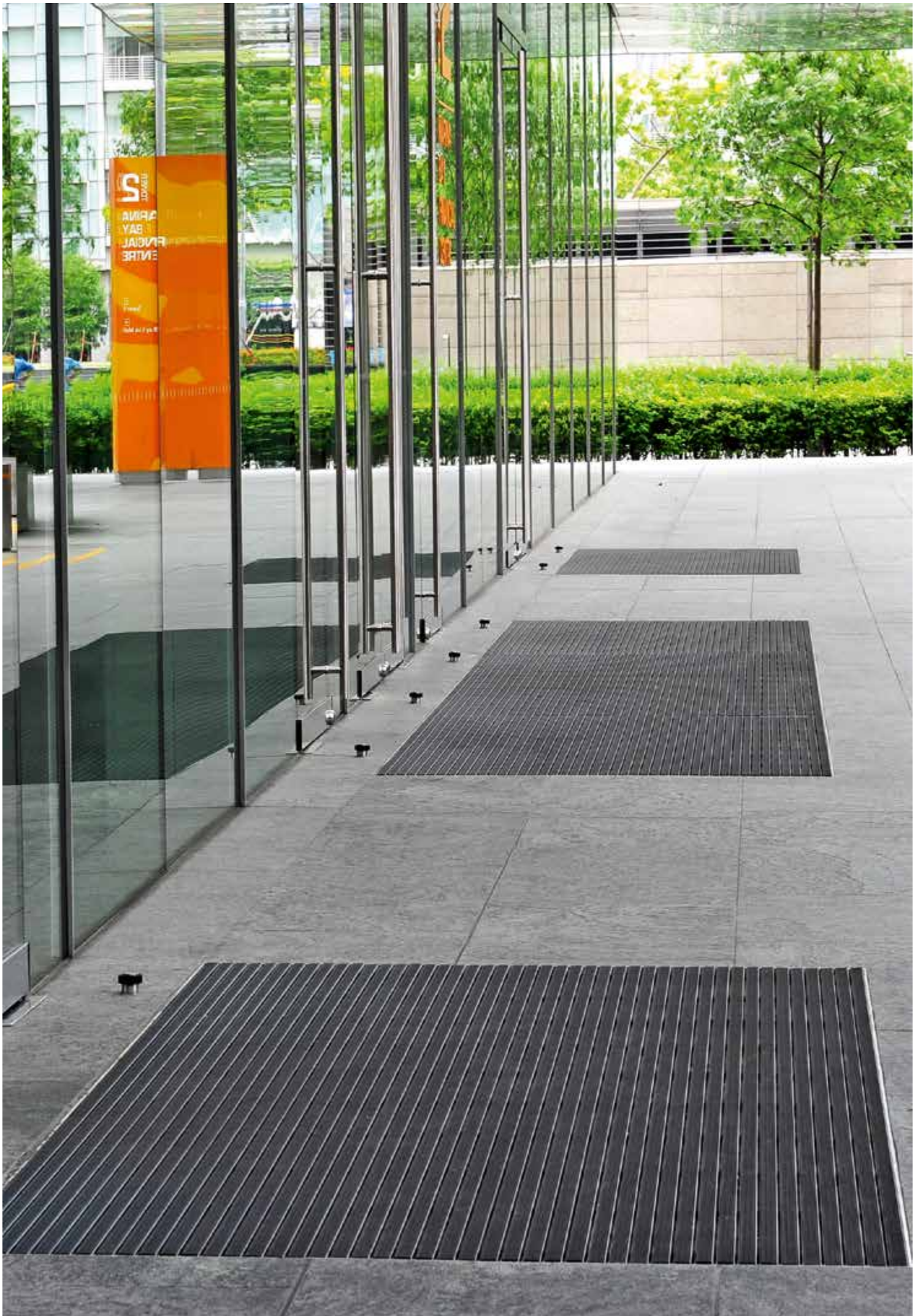



# 3

## MATTING SYSTEMS FOR OUTDOOR AREAS

### NORMAL TRAFFIC

- 40 TOP CLEAN TREND® FOR NORMAL LOAD
- 42 TOP CLEAN TREND® XL FOR LARGE AREAS
- 52 TOP CLEAN BRUSH BRUSH STRIP

### HIGH TRAFFIC | EXTREME TO HEAVY LOAD

- 44 TOP CLEAN STABIL FOR HEAVY LOAD
- 46 TOP CLEAN STABIL XL FOR LARGE AREAS
- 48 TOP CLEAN OBJEKT FOR EXTREME LOAD
- 50 TOP CLEAN HIGH FOR EXTREME AND HEAVY LOAD

## TOP CLEAN TREND® FOR NORMAL LOAD

We recommend durable rubber profiles with anti-slip features, alternating with scraper bars and cassette brushes, as an efficient cleaning concept for outdoor areas. This Top Clean TREND® version is particularly weather-resistant and non-corrosive. Dirt and moisture are collected outside the building. Scraper Bars installed between the profiles increase the cleaning effect even more. Sound-absorbing, dimensionally stable, rollable and easy to clean. Available in any width and length. Special shapes at extra charge.

<b>Aluprofile</b>	Warp resistant aluminium profile (alloy EN AW 6060, wall thickness up to 1.5 mm) for fully supported installation.
<b>Upper/Combinations</b>	You may choose between various installation options or even combine several options: <ul style="list-style-type: none"> <li>• Anti-slip Grooved Rubber (EPDM), with lengthwise and crosswise grooves, heavy-duty and UV-resistant conforming to <b>DIN 7863</b> (German Industrial Standard), fire behavior for mat heights 10 mm and 17 mm = Bfl-s1, for mat heights 22 mm and 27 mm = Cfl-s1 conforming <b>DIN EN 13501-1</b> (German Industrial Standard).</li> <li>• Scraper Bars made of warp resistant aluminium profile.</li> <li>• Brush Strips made of robust polyamide 6.</li> <li>• Cassette Brush made of robust, heavy-duty polyamide 6, slip-resistant properties R 13 conforming to <b>DIN 51130</b> (German Industrial Standard).</li> </ul>
<b>Underside</b>	Base of the mat is mechanically fitted with rubber inserts for anti-slip and noise reduction.
<b>Connection</b>	Stainless steel wire rope V2A for Ø 2 mm for 12, and 17 mm mat height, Coated galvanized wire rope for 22 and 27 mm mat height.
<b>Lock</b>	Special threaded nipple with stainless steel screw (rust-proof).
<b>Profile Spacing</b>	5 mm. Profile spacing optional also in 3 mm for automatic door systems conforming to <b>DIN 18650</b> . Flexible spacers made of rubber.
<b>Profile Colours</b>	Natural aluminium. Profile can be supplied powder-coated to any RAL colour (for an extra charge).

#### Cassette Brush

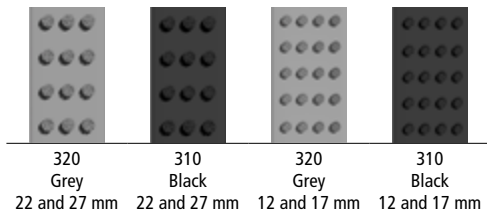

#### Grooved Rubber    Brush Strip

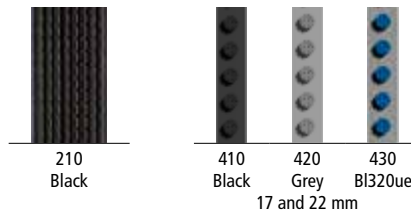



# TOP CLEAN TREND® POSSIBLE COMBINATIONS

## Top Clean TREND® with Grooved Rubber

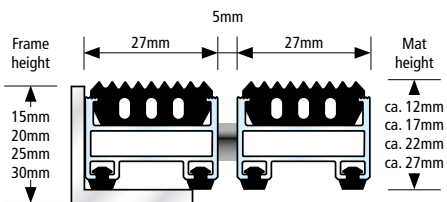

- For outdoor use
- Accessible
- Recyclable
- Rust-proof

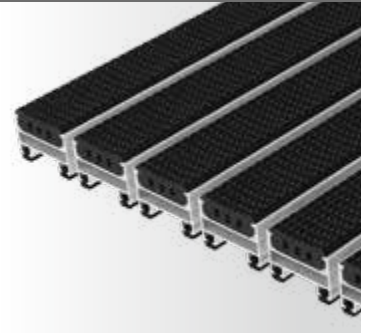

## Top Clean TREND® with Grooved Rubber and Brush Strip

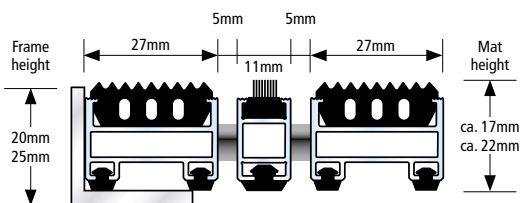

- For outdoor use
- Accessible
- Recyclable
- Rust-proof

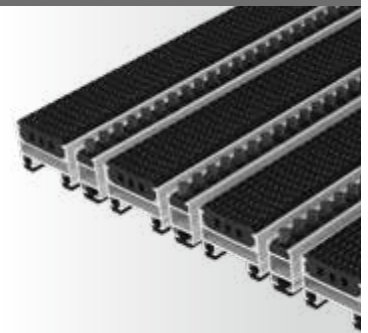

## Top Clean TREND® with Grooved Rubber and Cassette Brush

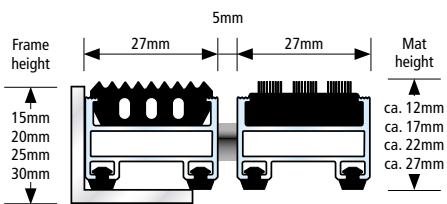

- For outdoor use
- Recyclable
- Rust-proof



## Top Clean TREND® with Cassette Brush

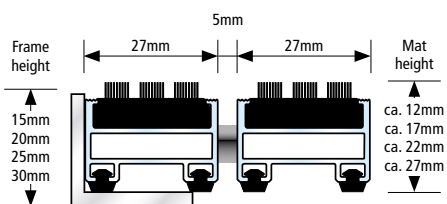

- For outdoor use
- Recyclable
- Rust-proof

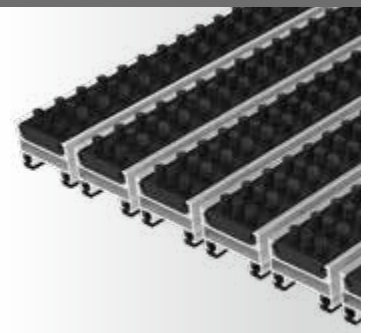

All profiles feature highly effective impact sound insulation!



## TOP CLEAN TREND® XL FOR LARGE AREAS

Tailor-made solutions for spacious, architecturally ambitious entrance areas. 37 mm rubber profiles with anti-slip features and brush cassettes collect dirt efficiently and provide walking comfort on the mats. Adding scraper bars to your customized solution further increases the cleaning performance. Also available with brush strips. All mats are non-corrosive, sound-absorbing, dimensionally stable, rollable and easy to clean. Available in any width and length. Special shapes at extra charge.

<b>Aluprofile</b>	Warp resistant aluminium profile (alloy EN AW 6060, wall thickness up to 1.5 mm) for fully supported installation.
<b>Upper/Combinations</b>	You may choose between various installation options or even combine several options: <ul style="list-style-type: none"> <li>• Anti-slip Grooved Rubber (EPDM), with lengthwise and crosswise grooves, heavy-duty and UV-resistant conforming to <b>DIN 7863</b> (German Industrial Standard), fire behavior Cfl-s1 conforming <b>DIN EN 13501-1</b> (German Industrial Standard).</li> <li>• Brush Strips made of robust polyamide 6.</li> <li>• Cassette Brush made of robust, heavy-duty polyamide 6, slip-resistant properties R 13 conforming to <b>DIN 51130</b> (German Industrial Standard).</li> </ul>
<b>Underside</b>	Base of the mat is mechanically fitted with rubber inserts for anti-slip and noise reduction.
<b>Connection</b>	Coated galvanized wire rope.
<b>Lock</b>	Special threaded nipple with stainless steel screw (rust-proof).
<b>Profile Spacing</b>	5 mm. Flexible spacers made of rubber.
<b>Profile Colours</b>	Natural aluminium. Profile can be supplied powder-coated to any RAL colour (for an extra charge).

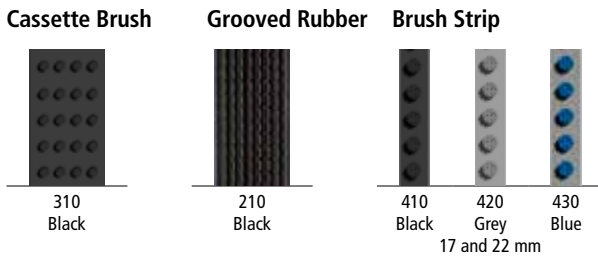

# TOP CLEAN TREND® XL POSSIBLE COMBINATIONS

## Top Clean TREND® XL with Grooved Rubber

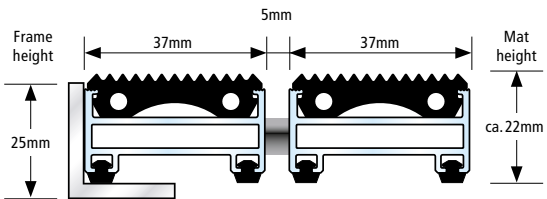

-  For outdoor use
-  Accessible
-  Recyclable
-  Rust-proof

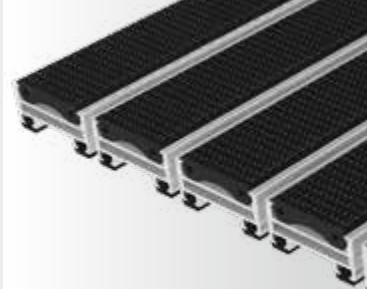

## Top Clean TREND® XL with Grooved Rubber and Brush Strip

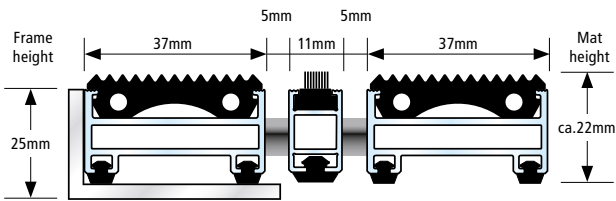

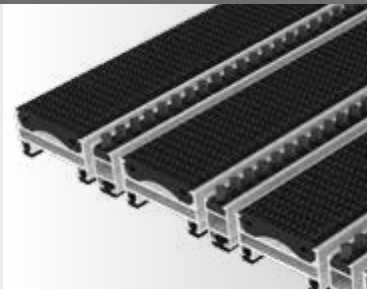

-  For outdoor use
-  Accessible
-  Recyclable
-  Rust-proof

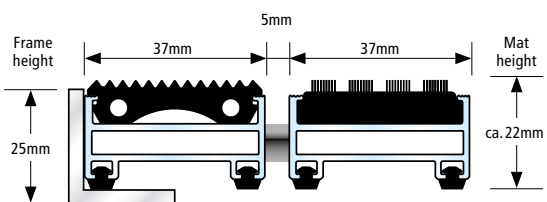

## Top Clean TREND® XL with Grooved Rubber and Cassette Brush



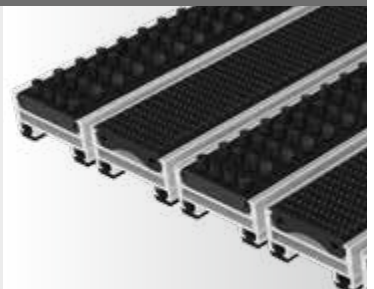

-  For outdoor use
-  Recyclable
-  Rust-proof

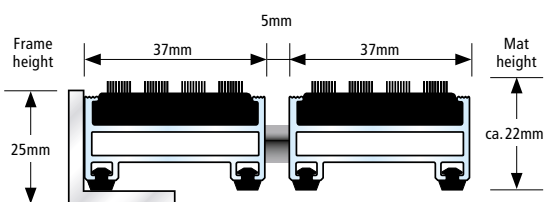

## Top Clean TREND® XL with Cassette Brush



-  For outdoor use
-  Recyclable
-  Rust-proof

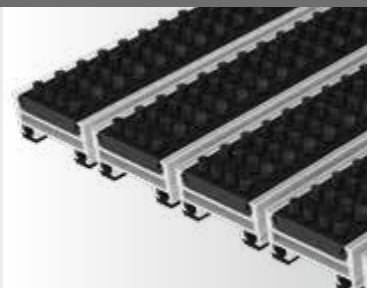

All profiles feature highly effective impact sound insulation!



## TOP CLEAN STABIL FOR HEAVY LOAD

Extreme load – this entrance matting system with a strong cleaning performance has an enormous load capacity, even with only 10 mm profile height. Profiles are dimensionally stable and extremely durable. We recommend this system for entrance areas with high traffic. Suitable for lift trucks and transport trolleys. Rubber profiles alternating with cassette brushes and scraper bars provide optimal protection against dirt and moisture. Sound-absorbing, dimensionally stable, rollable and easy to clean. Available in any width and length. Special shapes at extra charge.

<b>Aluprofile</b>	Warp resistant aluminium profile (alloy EN AW 6060-6063, wall thickness up to 2.5 mm) for fully supported and self-supporting installation (substructure on site, maximum distance between supports 300 mm).
<b>Upper/ Combinations</b>	You may choose between various installation options or even combine several options: <ul style="list-style-type: none"> <li>• Anti-slip Grooved Rubber (EPDM), with lengthwise and crosswise grooves, heavy-duty and UV-resistant conforming to <b>DIN 7863</b> (German Industrial Standard), fire behavior for mat heights 12 mm and 17 mm = Bfl-s1, for mat height 22 mm = Cfl-s1 conforming <b>DIN EN 13501-1</b> (German Industrial Standard).</li> <li>• Cassette Brush made of robust, heavy-duty polyamide 6, slip-resistant properties R 13 conforming to <b>DIN 51130</b> (German Industrial Standard).</li> </ul>
<b>Underside</b>	Base of the mat is mechanically fitted with rubber inserts for anti-slip and noise reduction.
<b>Connection</b>	Stainless steel wire rope V2A Ø 2 mm for 12 and 17 mm mat height, Stainless steel wire rope V2A Ø 3 for 22 mm mat height.
<b>Lock</b>	Special threaded nipple with stainless steel screw (rust-proof).
<b>Profile Spacing</b>	5 mm. Profile spacing optional also in 3 mm for automatic door systems conforming to <b>DIN 18650</b> . Flexible spacers made of rubber.
<b>Profile Colours</b>	Natural aluminium. Profile can be supplied powder-coated to any RAL colour (for an extra charge).

#### Cassette Brush



320  
Grey  
22 mm

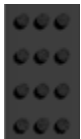

310  
Black  
22 mm



320  
Grey  
12 and 17 mm



310  
Black  
12 and 17 mm

#### Grooved Rubber



210  
Black

# TOP CLEAN STABIL POSSIBLE COMBINATIONS

## Top Clean STABIL with Grooved Rubber

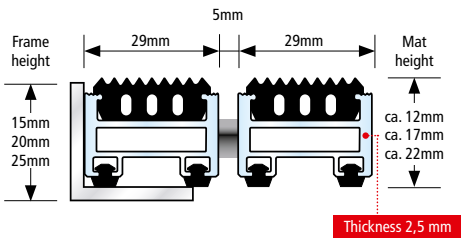

- For outdoor use
- Accessible
- Accessible with hand lift truck
- Recyclable
- Rust-proof

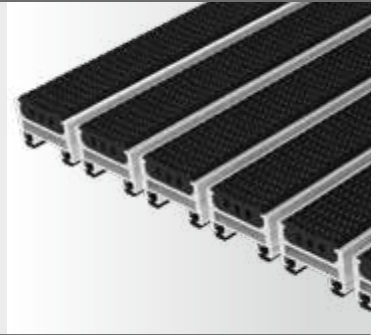

## Top Clean STABIL with Grooved Rubber and Cassette Brush

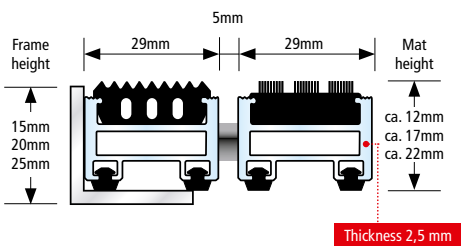

- For outdoor use
- Accessible with hand lift truck
- Recyclable
- Rust-proof

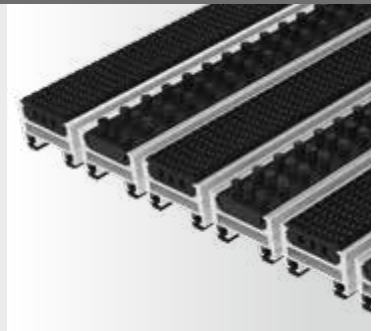

## Top Clean STABIL with Cassette Brush

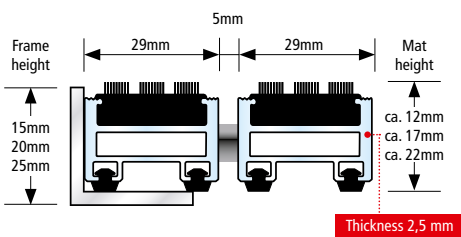

- For outdoor use
- Accessible with hand lift truck
- Recyclable
- Rust-proof

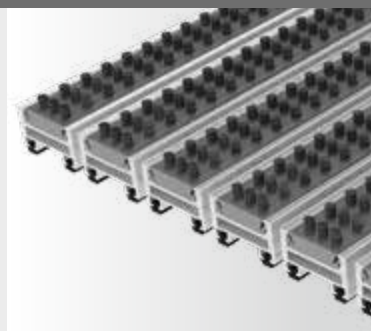

All profiles feature highly effective impact sound insulation!



## TOP CLEAN STABIL XL POSSIBLE COMBINATIONS

This Top Clean version provides superior load capacity and reliable protection against dirt and moisture for architecturally ambitious entrance areas. The 39 mm profiles are ideally suited for large areas. Thanks to its high load capacity, this system is an efficient, durable solution. The rubber and brush profiles as well as the scraper bars used feature anti-slip properties. Sound-absorbing, dimensionally stable, rollable and easy to clean. Available in any width and length. Special shapes at extra charge.

<b>Aluprofile</b>	Warp resistant aluminium profile (alloy EN AW 6060, wall thickness up to 2.5 mm) for fully supported and self-supporting installation (substructure on site, maximum distance between supports 300 mm).
<b>Upper/Combinations</b>	You may choose between various installation options or even combine several options: <ul style="list-style-type: none"> <li>• Anti-slip Grooved Rubber (EPDM), with lengthwise and crosswise grooves, heavy-duty and UV-resistant conforming to <b>DIN 7863</b> (German Industrial Standard), fire behavior Cfl-s1 conforming <b>DIN EN 13501-1</b> (German Industrial Standard).</li> <li>• Cassette Brush made of robust, heavy-duty polyamide 6, slip-resistant properties R 13 conforming to <b>DIN 51130</b> (German Industrial Standard).</li> </ul>
<b>Underside</b>	Base of the mat is mechanically fitted with rubber inserts for anti-slip and noise reduction.
<b>Connection</b>	Stainless steel wire rope V2A for Ø 3 for 22 and 27 mm mat height.
<b>Lock</b>	Special threaded nipple with stainless steel screws (rust-proof).
<b>Profile Spacing</b>	5 mm. Flexible spacers made of rubber.
<b>Profile Colours</b>	Natural aluminium. Profile can be supplied powder-coated to any RAL colour (for an extra charge).

**Cassette Brush**



310  
Black

**Grooved Rubber**



210  
Black

# TOP CLEAN STABIL XL POSSIBLE COMBINATIONS

## Top Clean STABIL XL with Grooved Rubber

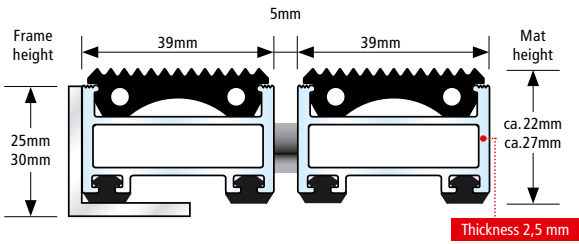

- For outdoor use
- Accessible
- Accessible with hand lift truck
- Recyclable
- Rust-proof

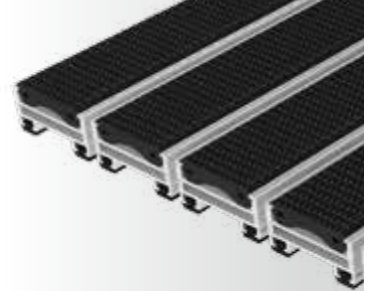

## Top Clean STABIL XL with Grooved Rubber and Cassette Brush

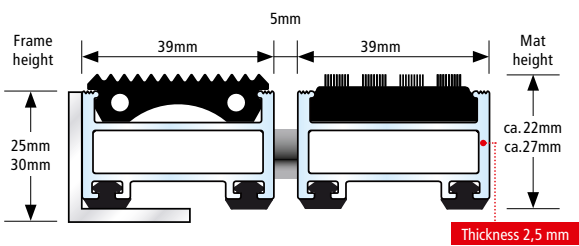

- For outdoor use
- Accessible with hand lift truck
- Recyclable
- Rust-proof

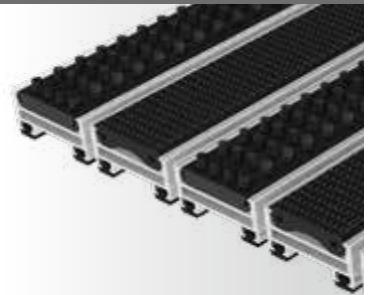

## Top Clean STABIL XL with Cassette Brush

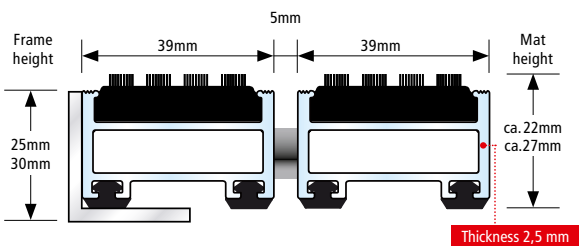

- For outdoor use
- Accessible with hand lift truck
- Recyclable
- Rust-proof



All profiles feature highly effective impact sound insulation!



## TOP CLEAN OBJEKT FOR EXTREME HEAVY LOAD

In-depth performance tests have confirmed the outstanding load capacity of the Top Clean OBJEKT version with 40 mm profiles. Suitable for any type of transport trolley. This version has been developed for areas with extremely high pedestrian traffic. We recommend Top Clean OBJEKT for the outdoor areas of shopping malls, airports, and stations. The robust cassette brushes for efficient, long-term dirt collection and moisture stop. Alternating rubber profiles are applied to further increase the cleaning performance.

<b>Aluprofile</b>	Warp resistant aluminium profile (alloy EN AW 6060, wall thickness up to 3.0 mm) for fully supported and self-supporting installation (substructure on site, maximum distance between supports 300 mm).
<b>Upper/ Combinations</b>	You may choose between various installation options or even combine several options: <ul style="list-style-type: none"> <li>• Anti-slip Grooved Rubber (EPDM), with lengthwise and crosswise grooves, heavy-duty and UV-resistant conforming to <b>DIN 7863</b> (German Industrial Standard), fire behavior Cfl-s1 conforming <b>DIN EN 13501-1</b> (German Industrial Standard).</li> <li>• Cassette Brush made of robust, heavy-duty polyamide 6, slip-resistant properties R 13 conforming to <b>DIN 51130</b> (German Industrial Standard).</li> </ul>
<b>Underside</b>	Base of the mat is mechanically fitted with rubber inserts for anti-slip and noise reduction.
<b>Connection</b>	Stainless steel wire rope V2A for Ø 3 mm.
<b>Lock</b>	Special threaded nipple with stainless steel screw (rust-proof).
<b>Profile Spacing</b>	5 mm. Flexible spacers made of rubber.
<b>Profile Colours</b>	Natural aluminium. Profile can be supplied powder-coated to any RAL colour (for an extra charge).

**Cassette Brush**

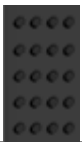

310  
Black

**Grooved Rubber**









210  
Black

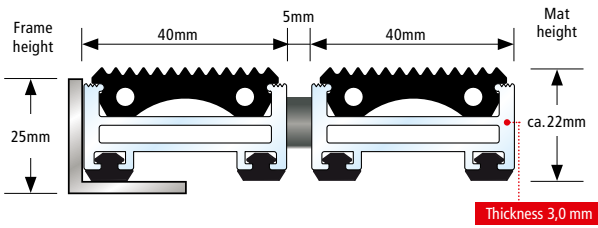

# TOP CLEAN OBJEKT POSSIBLE COMBINATIONS

## Top Clean OBJEKT with Grooved Rubber





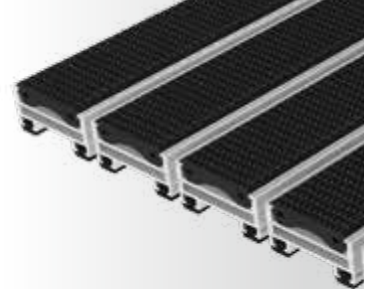

-  For outdoor use
-  Accessible
-  Accessible with hand lift truck
-  Accessible with forklift truck
-  Recyclable
-  Rust-proof

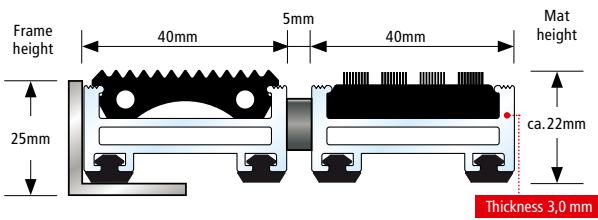

## Top Clean OBJEKT with Grooved Rubber and Cassette Brush



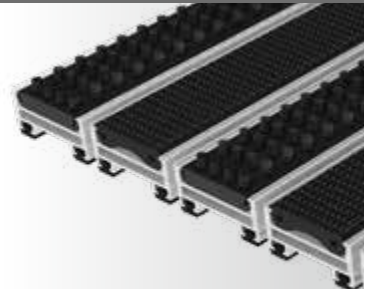

-  For outdoor use
-  Accessible with hand lift truck
-  Accessible with forklift truck
-  Recyclable
-  Rust-proof

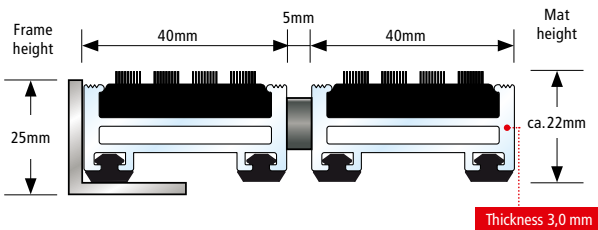

## Top Clean OBJEKT with Cassette Brush



-  For outdoor use
-  Accessible with hand lift truck
-  Accessible with forklift truck
-  Recyclable
-  Rust-proof

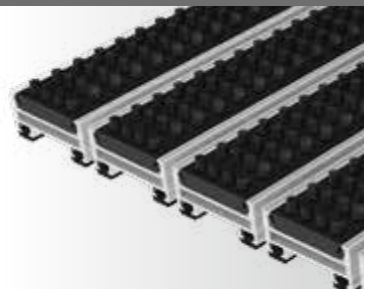

All profiles feature highly effective impact sound insulation!



# TOP CLEAN HIGH FOR EXTREME USAGE AND HEAVY LOAD

Von unabhängigen Prüfungsinstituten wird vollflächig verlegten Top Clean HIGH Matten eine hohe Belastbarkeit bis zu 6.000 kg bestätigt. Stabile Rahmen und Mattenhöhen von 42 mm bieten auch für extrem frequentierte Eingangsbereiche eine herausragende Langlebigkeit. Die individuellen Anwendungslösungen punkten mit Profileinlagen in strapazierfähigem Rips sowie intensiv reinigenden Bürstenprofilen. Schalldämmend, maßhaltig, aufrollbar und leicht zu reinigen. Anfertigung in jeder Breite und Tiefe. Sonderformen gegen Aufpreis.

<b>Aluprofile</b>	Warp resistant aluminium profile (alloy EN AW 6060, wall thickness up to 2.5 mm) for fully supported and self-supporting installation (substructure on site, maximum distance between supports 300 mm).
<b>Upper/Combinations</b>	You may choose between various installation options or even combine several options: <ul style="list-style-type: none"> <li>• Anti-slip Grooved Rubber (EPDM), with lengthwise and crosswise grooves, heavy-duty and UV-resistant conforming to <b>DIN 7863</b> (German Industrial Standard), fire behavior Cfl-s1 conforming <b>DIN EN 13501-1</b> (German Industrial Standard).</li> <li>• Cassette Brush made of robust, heavy-duty polyamide 6, slip-resistant properties R 13 conforming to <b>DIN 51130</b> (German Industrial Standard).</li> </ul>
<b>Underside</b>	Slip resistance and noise reduction achieved by bonded PE-foam.
<b>Connection</b>	Stainless steel wire rope V2A for Ø 3 mm.
<b>Lock</b>	Special threaded nipple with stainless steel screw (rust-proof).
<b>Profile Spacing</b>	5 mm. Flexible spacers made of rubber.
<b>Profile Colours</b>	Natural aluminium. Profile can be supplied powder-coated to any RAL colour (for an extra charge).

#### Cassette Brush

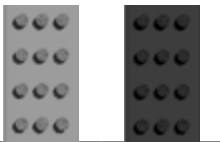

320  
Grey

310  
Black

#### Grooved Rubber



210  
Black

# TOP CLEAN HIGH POSSIBLE COMBINATIONS

## Top Clean HIGH with Grooved Rubber

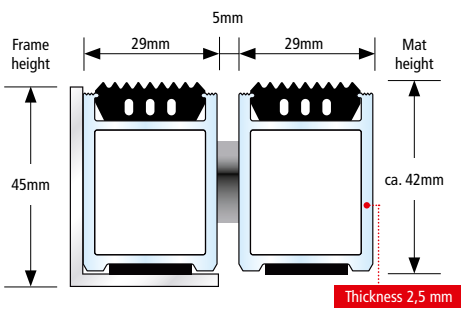

- For outdoor use
- Accessible
- Accessible with hand lift truck
- Accessible with forklift truck
- Recyclable
- Rust-proof

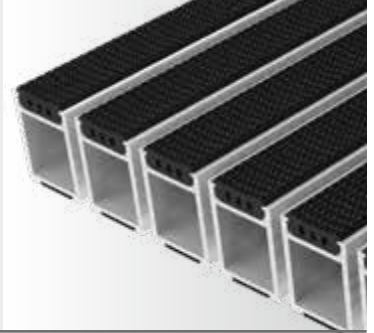

## Top Clean HIGH with Grooved Rubber and Cassette Brush

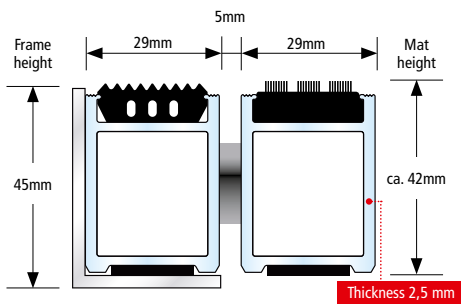

- For outdoor use
- Accessible with hand lift truck
- Accessible with forklift truck
- Recyclable
- Rust-proof

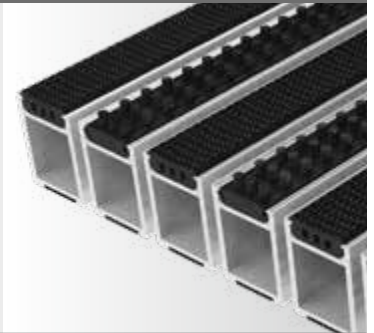

## Top Clean HIGH with Cassette Brush

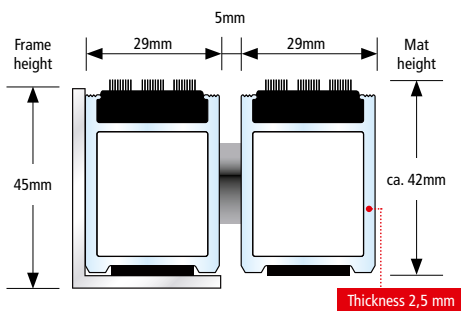

- For outdoor use
- Accessible with hand lift truck
- Accessible with forklift truck
- Recyclable
- Rust-proof

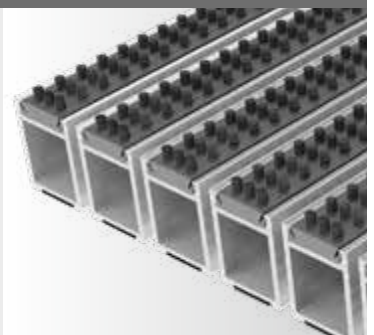

All profiles feature highly effective impact sound insulation!



## TOP CLEAN BRUSH BRUSH STRIP

Impressive Functionality and Design in One System. Top Clean BRUSH has slim aluminium profiles for effective dirt collection. Brush strips are included for maximum cleaning power, even in areas where shoes with heavy sole profiles are used. We recommend this version in particular for use in winter sports areas and sports venues. Top Clean BRUSH features sound insulation and is dimensionally stable, rollable and easy to clean. This Top Clean system is available in any width and length; special shapes are available on request.

<b>Aluprofile</b>	Warp resistant aluminium profile (alloy EN AW 6060, wall thickness up to 1,1 mm) for fully supported installation.
<b>Upper</b>	Brush Strips made of robust polyamide 6.
<b>Underside</b>	Base of the mat is mechanically fitted with rubber inserts for slip resistance and noise reduction.
<b>Connection</b>	Stainless steel wire rope V2A for Ø 2 mm for 17 mm mat height, coated galvanized wire rope for 22 mm mat height.
<b>Lock</b>	Special threaded nipple with stainless steel screw (rust-proof).
<b>Profile Spacing</b>	5 mm. Flexible spacers made of rubber.
<b>Profile Colours</b>	Natural aluminium. Profile can be supplied powder-coated to any RAL colour (for an extra charge).

#### Brush Strip

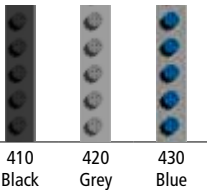

410 Black    420 Grey    430 Blue

#### Top Clean BRUSH with Brush Strip

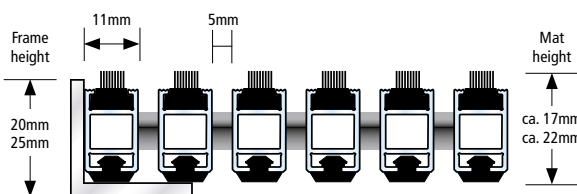

- For outdoor use
- Recyclable



All profiles feature highly effective impact sound insulation!



# 4

## SAFETY IN ENTRANCE AREAS

- 54 SAFE CLEAN TREND:  
A LUMINESCENT SAFETY MAT COMBINATION
- 56 VISUAL AND TACTILE GUIDANCE SYSTEMS  
FOR ENTRANCE AREAS

**BRIGHT**  
EFFECT



# SAFE CLEAN TREND A LUMINESCENT SAFETY MAT COMBINATION WITH TACTILE GUIDANCE SYSTEM

We developed the Safe Clean Trend safety mat to complement integrated safety systems in public buildings. Thanks to white safety strips that sharply contrast to the remaining components, this entrance matting system is also particularly visible, for visually impaired persons. This is especially important since entrance mats have superior anti-slip features, compared to the surrounding flooring.

The Safe Clean TREND system shows its full strength in the event of sudden light failure: Special pigments in the safety strips collect luminous energy and provide a constant source of light. The mat remains visible even in complete darkness. Entrances, exits, and escape doors are much easier to locate thanks to the luminescent features of Safe Clean TREND. Other safety features, such as luminescent escape route signs and floor guidance strips, are thus complemented in an optimal way.





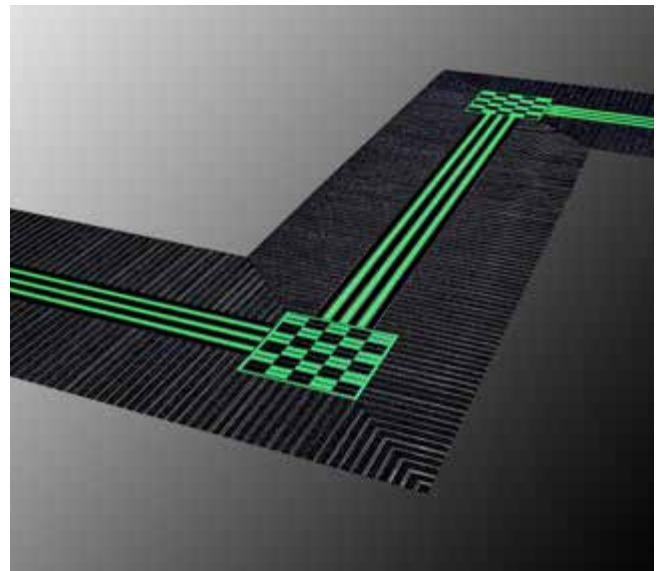
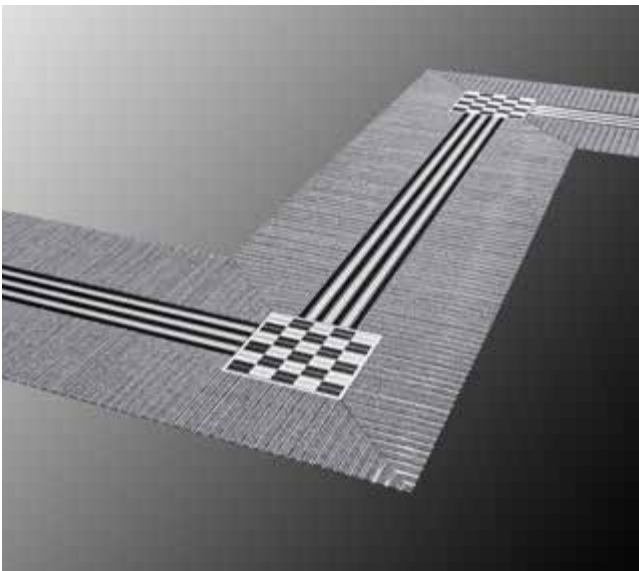

Tactile system combinations: Tactile floor indicators are important aids for handicapped or visually impaired persons. The luminescent safety strips of the Safe Clean TREND mat can easily be combined with our tactile guidance system. Orientation aids that address several human senses provide additional safety in entrance areas. The Safe Clean TREND system has received the 2017 ICONIC AWARD: Interior Innovation – Best of Best.

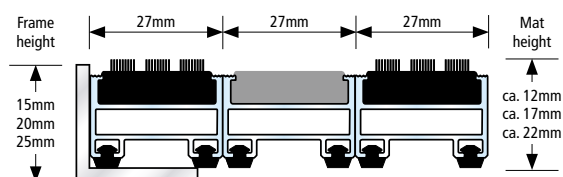
Please contact us if you are planning to install a safety system in your entrance area. We will gladly advise you.



## Tactile Guidance System Safe Clean TREND



-  Tactile / visual guidance system
-  Accessible
-  For use indoors or in covered outdoor areas
-  For outdoor use
-  Recyclable
-  Rust-proof

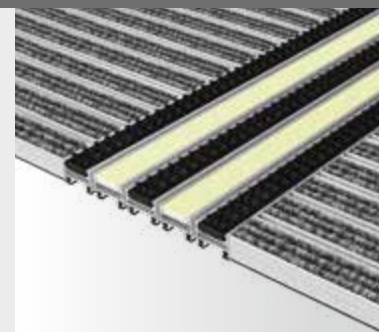

All profiles feature highly effective impact sound insulation!



Visual and tactile guidance systems integrated into the mats assist blind persons and people with impaired vision to find their way indoor the building. The guidance system is available in any width and may be used with any profile. Combining various profiles is possible. All colours for ribbed carpet and cassette brushes are available when using a tactile guidance system.





# VISUAL AND TACTILE GUIDANCE SYSTEMS FOR ENTRANCE AREAS

In public buildings in particular, visual guidance and orientation systems in entrance areas are essential. For visually impaired persons, however, additional tactile systems are necessary for orientation. We have developed a safety concept using floor indicators to allow visually impaired persons to find their way inside the building.

Customized, accessible solutions on the basis of Top Clean aluminium profile mats with integrated guidance strips are available. We apply profile inlays with various structures and colours to facilitate orientation. Contrasting installation patterns support the guidance concept. The tactile orientation aids can be easily identified with a white cane. The system addresses various human senses, providing increased safety.

## Compatible with any Profile

The design of our guidance system, according to DIN 18040-1 for accessible development, may be adapted individually to architectural concepts. The system is compatible with any profile in the comprehensive Top Clean programme by us. A range of variants with ribbed carpet, scraper bars and brush cassettes is available in numerous colours and various profile heights. In addition, we provide powder-coated aluminium profiles in RAL colours.





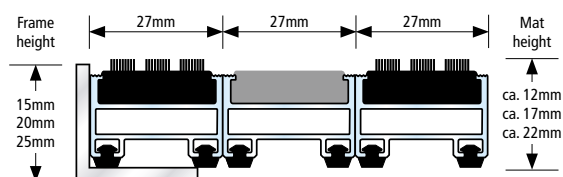

## Tailor-Made Solutions for Indoor and Outdoor Zones

The Top Clean programme comprises solutions for indoor and outdoor zones with normal and heavy pedestrian traffic – tailor-made and in any size. Special shapes with gaps, diagonal or circular cutting are available upon your request. Continuous, sound-absorbing rubber profiles on the underside prevent footfall noise effectively.



## Tactile Guidance System Top Clean TREND®



-  Tactile/ visual guidance system
-  Accessible
-  For use indoors or in covered outdoor areas
-  For outdoor use
-  Recyclable
-  Rust-proof

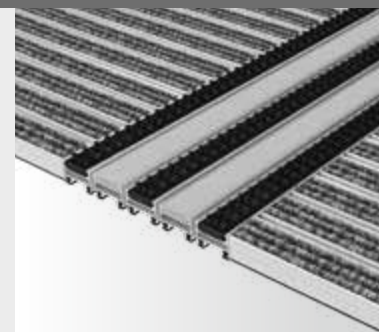

All profiles feature highly effective impact sound insulation!







# 5

## DESIGN IN ENTRANCE AREAS

- 61 TOP CLEAN TREND® CURVE FOR EXCLUSIVE ENTRANCE AREAS
- 62 MATTING SYSTEMS IN YOUR CORPORATE DESIGN
- 63 STAINLESS STEEL PROFILE WITH LOGO
- 63 LOGO PROFILE WITH LED ILLUMINATION
- 64 POWDER-COATED PROFILES ACCORDING TO RAL CHART
- 64 ANODISED PROFILE SURFACES

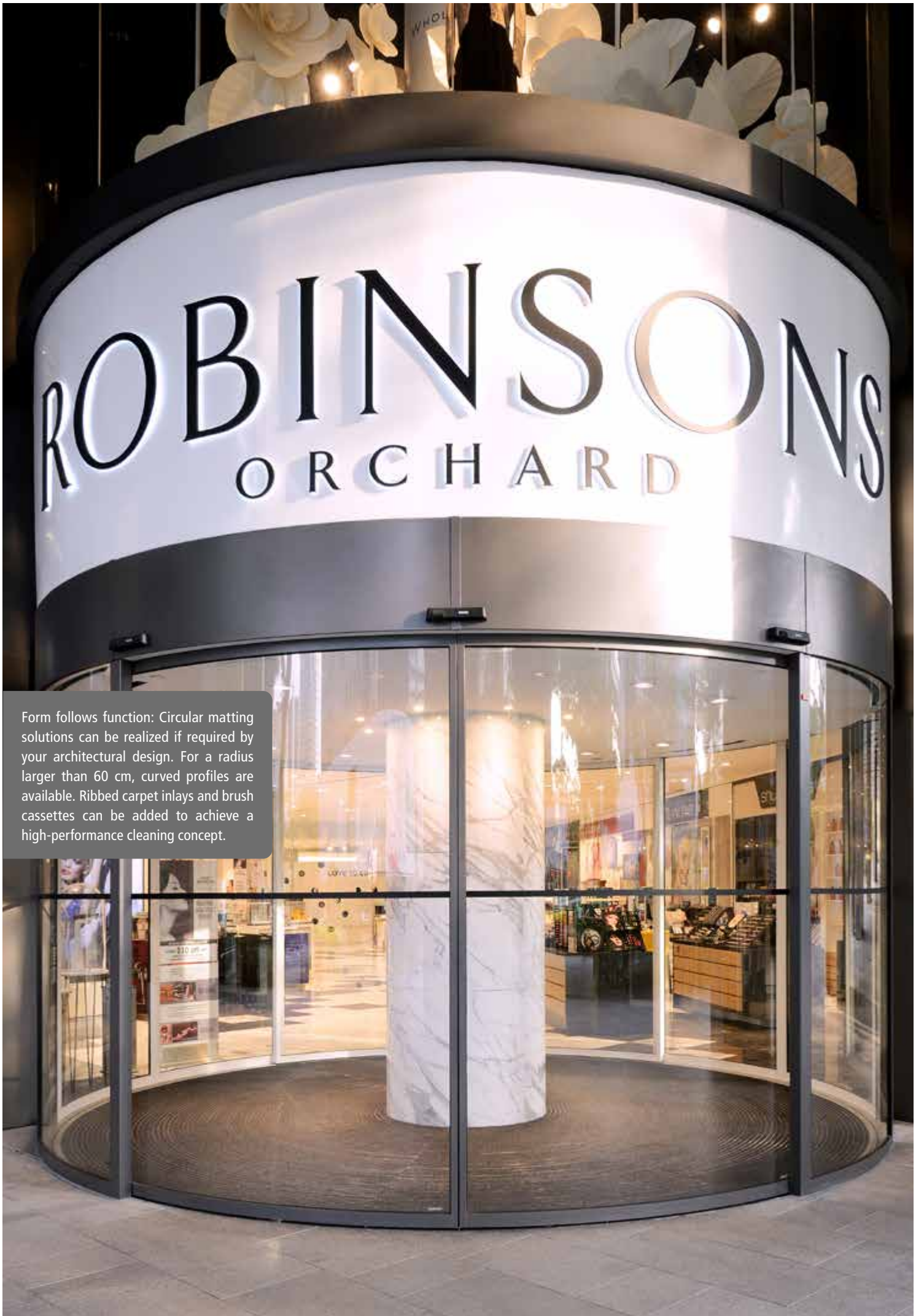

Form follows function: Circular matting solutions can be realized if required by your architectural design. For a radius larger than 60 cm, curved profiles are available. Ribbed carpet inlays and brush cassettes can be added to achieve a high-performance cleaning concept.

# TOP CLEAN TREND® CURVE FOR EXCLUSIVE ENTRANCE AREAS

This system combines high cleaning power with innovative design. It is available in custom-made versions with curves and a variety of profiles according to your individual preferences. Featuring different variants with ribbed carpet or cassette brush, this solution is recommended for interior or outdoor areas. Also available is the special Top Clean STABIL CURVE design for heavy-duty use. Top Clean TREND® CURVE features sound insulation, is dimensionally stable and easy to clean; not rollable. Delivery time on request.

<b>Aluprofile</b>	Warp resistant aluminium profile (alloy EN AW 6060, wall thickness up to 1.5 mm) for fully supported installation.
<b>Upper</b>	Different deposit options are available or can be combined with each other. <ul style="list-style-type: none"> <li>• Ribbed Carpet: UV-resistant heavy-duty polypropylene, slip-resistant properties R 11 conforming to <b>DIN 51130</b> (German Industrial Standard).</li> <li>• Cassette Brush made of robust, heavy-duty polyamide 6, slip-resistant properties R 13 conforming to <b>DIN 51130</b> (German Industrial Standard).</li> <li>• On request: Anti-slip Grooved Rubber (EPDM), with lengthwise and crosswise grooves, robust and UV resistant in accordance with <b>DIN 7863</b>, non-skid category R9 in accordance with <b>DIN 51130</b> (German Industrial Standard), fire behavior for mat height 17 mm = Bfl-s1, for mat height 22 mm = Cfl-s1 conforming <b>DIN EN 13501-1</b> (German Industrial Standard).</li> </ul>
<b>Underside</b>	Base of the mat is mechanically fitted with rubber inserts for anti-slip and noise reduction.
<b>Connection</b>	Stainless steel wire rope V2A for Ø 2 mm for 17 mm mat height, coated galvanized wire rope for 22 mm mat height.
<b>Lock</b>	Special threaded nipple with stainless steel screw (rust-proof).
<b>Profile Spacing</b>	4 mm. Flexible spacers made of rubber.
<b>Dimensions</b>	Smallest bending radius is 60 cm. Largest one-piece profile length (arc length) is 300 cm.
<b>Profile Colours</b>	Natural Aluminium.

ALSO AVAILABLE: STABIL VERSION

## Standard Colours · Special Colour options page 20

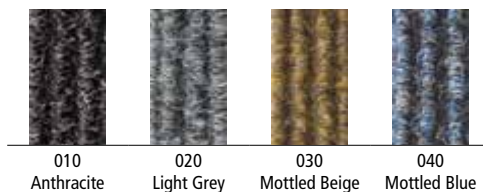

## Cassette Brush

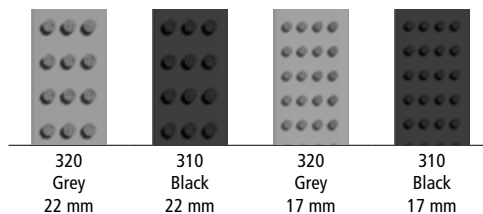

## Grooved Rubber

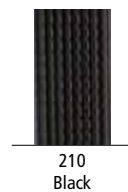

Due to technical limitations colours are only approximate.

## Top Clean TREND® CURVE

Model Top Clean TREND®

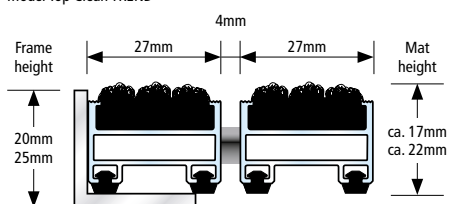

- For use indoors or in covered outdoor areas
- For outdoor use
- Accessible
- Recyclable
- Rust-proof

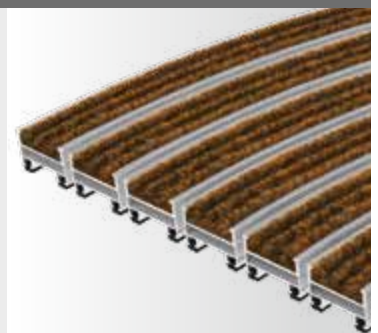

All profiles feature highly effective impact sound insulation!



# FIRST IMPRESSIONS LAST! MATTING SYSTEMS IN YOUR CORPORATE DESIGN

The entrance area should reflect a company's identity and values. A perfectly arranged entrance is key for visitors to feel comfortable when entering the building. Interior design, illumination, decoration – each element counts. A clean appearance is also an important factor. Here, efficient entrance matting systems from the TOP CLEAN brand are sustainable dirt collectors.

To make your company's appearance even more impressive, our entrance mats may become elements in your corporate design. We have developed various manufacturing techniques to integrate logos and lettering in TOP CLEAN systems. The results are eye-catching applications that provide high efficiency. Our profiles and inlays may be combined according to individual requirements – for public buildings, hotels, office or administration buildings.

All we need to realize the design you wish is an image or vector in jpg., pdf., or dxf. format. Please get in touch with us for further advice – our specialists will gladly support you!

### Durable Systems with a Ribbed Carpet Composition

We integrate logos, images, and shapes in Top Clean premium entrance mats with ribbed carpet – to handmade quality. In this elaborate procedure, comparable to marquetry, we use a laser to cut templates out of the ribbed carpet. The cut areas are then filled with ribbed carpet in colours according to our customers' corporate design. Please select any colour from our portfolio for applications (see page 20). Logo sizes must be compatible with mat sizes. Thanks to the laser technique applied, logos will not be abraded, even if mats are exposed to heavy pedestrian traffic. This ensures high durability, superior to print techniques.

Large-size logos and lettering fit best for this method. The technique is not suitable for filigree structures, colour gradients, or shades.



## STAINLESS STEEL PROFILE WITH LOGO

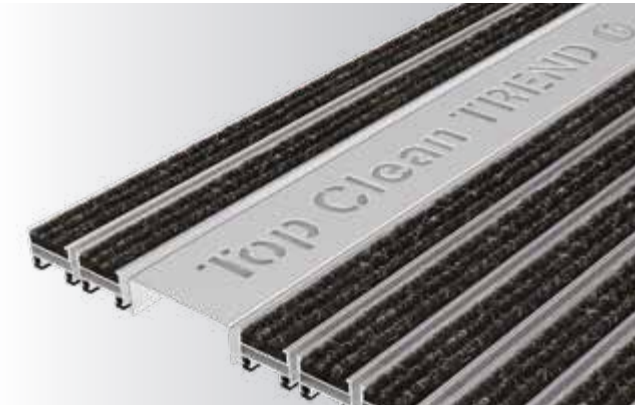

Stainless steel profiles with laser-cut logos provide an exclusive appearance in entrance areas. We offer tailor-made lettering – your slogan, company name, or welcome message in a broad range of font types and sizes. Again, all we need is an image or vector in a suitable data format.

Extra-wide profiles provide additional space for images or icons. Our profiles with ca. 60 mm width are made of high-quality, brush-finished chromium-nickel steel. According to the mat type chosen, the area designated for logos may be enlarged by the width of one or two aluminium profiles to a maximum of 120 mm.

A steel sheet coated in any RAL colour will be attached to the backside of the stainless steel profile. The classy component part is compatible with any Top Clean TREND and Top Clean STABIL variant.

## LOGO PROFILE WITH LED ILLUMINATION

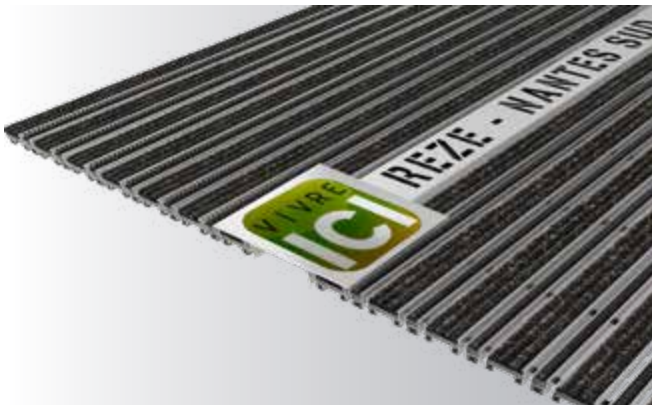

A high-end solution offering the highest degree of individuality in your entrance area: We can fill the laser-cuttings from your logo with transparent Plexiglas and illuminate them with an LED technique. When planning such an installation, power supply must be considered. The power supply unit must be integrated in the building equipment. A suitable cable must be installed in the mat frame on the underside of the logo bar (to be provided by the customer).

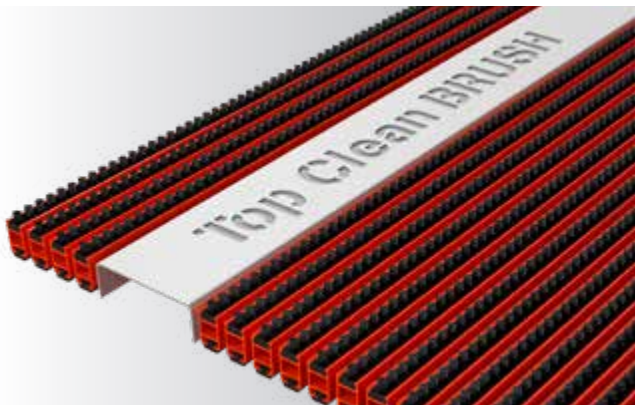

## POWDER-COATED PROFILES ACCORDING TO RAL-CHART

An accomplished mat edition is based on individuality – and thus on colours chosen by you. With powder-coated frames and aluminium profiles in all RAL colours, we draw on countless options in design and in combination with the colours of our ribbed carpet and brush inlays.



## ANODISED PROFILE SURFACES

A high-quality finish makes your one-off item perfect. Coloured anodised frames and aluminium profiles make for a fascinating and perfectly matched design. Be it in gold, black or bronze, the exclusive anodised finish sets the entrance matting system apart from the rest. It also has some impressive functional advantages. The anodisation makes the surface particularly hard and scratch-proof, while providing additional protection against corrosion or chemical influences.

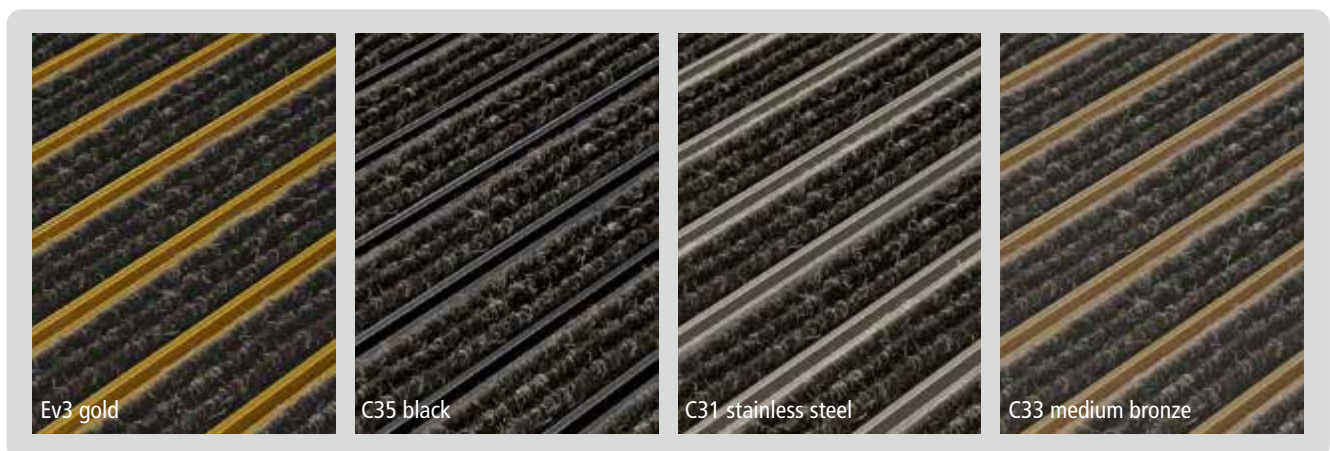



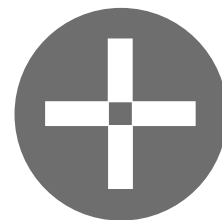

# 6

## ACCESSORIES

- 66 SPEZIAL ANGEL FRAME
- 66 T-BARS
- 67 INSTALLATION GUIDE FOR FRAMES
- 68 RAMPED EDGE FRAME
- 69 DIRT COLLECTION TRAYS

# SPEZIAL ANGLE FRAME

We recommend using the SPEZIAL angle frame for the installation of all Top Clean matting systems to ensure optimum fixation and easy release for cleaning purposes. Frame, corner connections and screws are made of one material, stainless steel or aluminium, to prevent corrosion. Frames are mitre-cut and ready for screw connection.

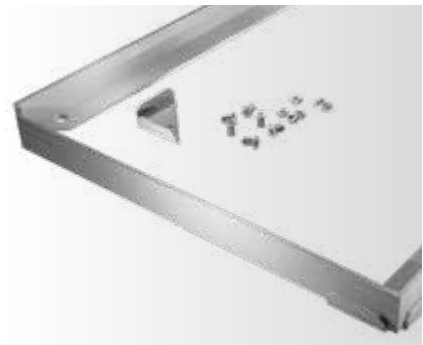

<b>Material</b>	Angle profiles made of aluminium or cold-rolled stainless steel (with rounded edges).
<b>Application</b>	Suitable for Top Clean mats 12, 17, 22, 27 and 42 mm.
<b>Height</b>	15, 20, 25, 30 and 45 mm.
<b>Colour</b>	Natural aluminium. Profile can be supplied powder-coated to any RAL colour (on request).
<b>Special Shapes</b>	Gaps, curves and diagonals can be produced on the basis of a technical drawing or template on request.



Frame with corner connector and anchor (delivered without installation)



Corner connectors and anchors are included, uninstalled when delivered



Red angle profiles provided as an installation aid for frames with over 2 m side length

# T-BARS

For all multi-part Top Clean mats without connectors in the profile direction. Simplifies the laying of the mat, especially after cleaning. Available on request.

<b>Material</b>	Aluminium T-Bars.
<b>Application</b>	Suitable for Top Clean mats 17, 22 and 27 mm.
<b>Height</b>	20, 25 or 30 mm.
<b>Colours</b>	Natural milled aluminium. For a surcharge also available in a powder-coated finish as per RAL colour chart.



## INSTALLATION GUIDE FOR FRAMES

- › When installing SPEZIAL angle frames, please make sure that the frame is flush with the floor (see illustration). Please note that the floor surface needs to be absolutely even for the matting to sit correctly in the frame once inserted. Repair uneven surfaces if necessary prior to frame installation. **Important: Provide clearance height to insert entrance mat into the frame.**
- › Note: For larger frames (over 2 m), red angle frames will be supplied as an installation aid. Please ensure they are inserted according to the enclosed drawing. They will guarantee there is no movement in the frame while the screed sets.
- › Mitred corners can be connected accurately by applying SPEZIAL corner connectors (included). Profiles of over 120cm include floor anchors that facilitate installation.
- › Installing frames and mats according to the enclosed installation guide ensures that mats sit evenly in the frame. Please note that correct installation of the frame is absolutely essential as there is only a 2mm gap between frame and mat.

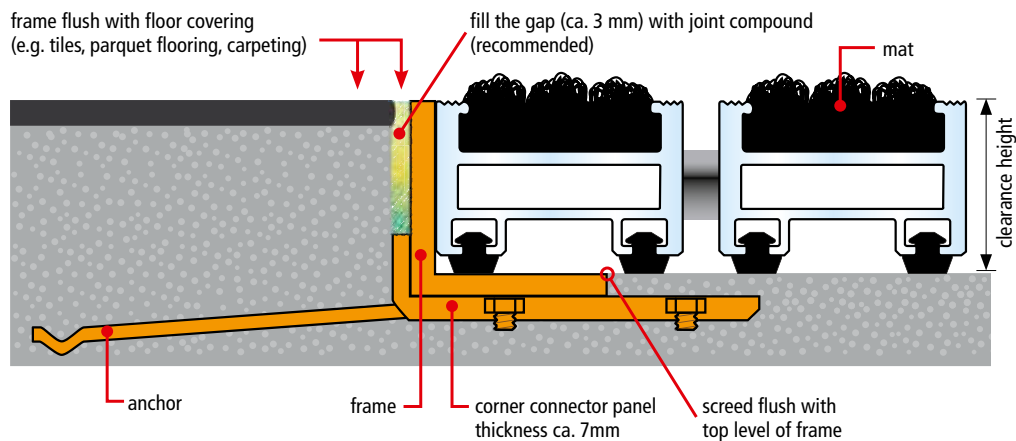

# RAMPED EDGE FRAME

The ramped edge frame is the ideal solution for non-recessed matting installations where no cut-outs on the floor are provided. All Top Clean matting with 10 or 17 mm can easily be equipped with ramped edge profiles. Entrance mats resting on ramped edge frames provide accessibility for wheelchairs and pushchairs.

<b>Material</b>	Warp resistant aluminium profile (alloy EN AW 6060).
<b>Application</b>	For use with Top Clean Trend 12 and 17 mm.
<b>Colours</b>	Natural Aluminium. On request powder coated aluminium profile can be supplied to any RAL colour (for an extra charge).
<b>Underside</b>	Antislip coating with PE-foam.

## Ramped Edge Frames

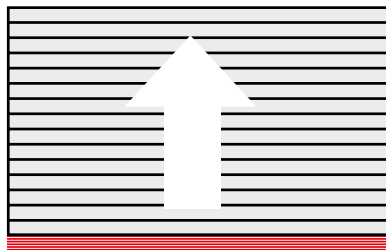

Ramped edge one-sided – the ramp is connected to the mat.

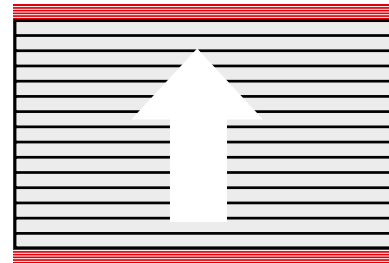

Ramped edge double-sided – the ramp is connected to the mat.

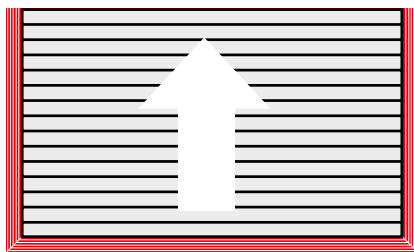

Ramped edge three-sided – the ramp is NOT connected to the mat, but can be secured to the floor.

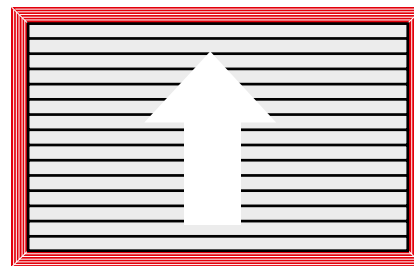

Ramped edge perimeter – the ramp is NOT connected to the mat, but can be secured to the floor.

## Ramped Edge Frame

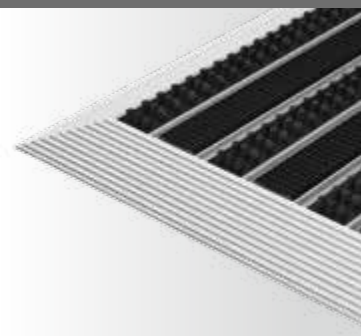
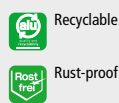
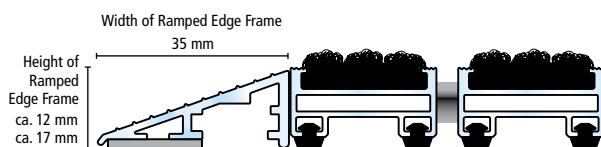

## DIRT COLLECTING TRAYS STAINLESS STEEL OR ALUMINIUM

The dirt collection trays are manufactured from stainless steel or aluminium. They feature extended dirt collection and water drainage. The size of the tray should correspond to the mat size; extra-large trays are optional. Profiles welded in the walking direction provide rigidity. Single-part trays have a maximum width of 2,900 mm and a length of 1,400 mm; larger multi-part versions are available.

<b>Material</b>	Welded stainless steel or aluminium. Intermediate profiles made of stainless steel or aluminium, maximum distance apart 250 mm, with gaps for water drain. Perimeter frame made of stainless steel or aluminium.
<b>Application</b>	For use with Top Clean STABIL 17 and 22 mm; for Top Clean STABIL XL 22 and 27 mm; for Top Clean OBJEKT 22 mm and for Top Clean HIGH 42 mm.
<b>Design</b>	Rectangular or in special shapes, multi-part trays consist of single segments with separate drainage; segments are connected via stainless steel or aluminium u-profiles (included).
<b>Drain</b>	A 60 mm (with 1½ inch threaded connection) stainless steel sieve is positioned in the centre of the tray or in a position of choice for connection to the drainage system.
<b>Special Shape</b>	Stainless steel or aluminium anchors can be fixed to the tray segments for precise assembly in the flooring (at an extra charge). Strengthened stainless steel or aluminium trays for heavy-duty areas with lift truck traffic are available (on request).



### Maximum dimensions for one-piece versions

Design	Standard height	Width	Length
Stainless steel or aluminium	50 mm	2,900 mm	1,400 mm
Stainless steel or aluminium	75 mm	2,850 mm	1,350 mm

Non-standard heights on enquiry.

Larger versions are delivered in several parts with a separate drain.

Price lists on enquiry.





Lowry outlet

BIBBY

5

Salford

24

Bell  
st smart



AJ Bell

Stadium

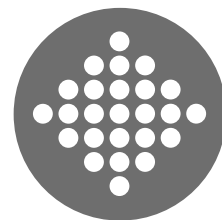

# 7

## UNIVERSAL MATS

- 72 MULTICLEAN | SURFACE LAY BARRIER MAT
- 73 LOGOCLEAN INDOOR | SURFACE LAY BARRIER MAT
- 74 ENTER | DURABLE CARPETING WITH REP SURFACE
- 75 MASTER | COARSE HAired REP MAT
- 76 KARO AS MINI | ULTRA FLAT HONEYCOMB RUBBER MAT
- 77 KARO AS | HONEYCOMB RUBBER MAT
- 78 DOMINO | HONEYCOMB RUBBER MAT
- 79 WALK | FINE RIBBED MAT

# MULTICLEAN SURFACE LAY BARRIER MAT



Our mats for entrance areas offer a wide range of different specifications to you. Follow our recommendations for an intelligent use of our mats in order to minimize cleaning costs as well as health and safety risks. Cover highly frequented areas with mats in order to keep them clean for a longer time and in order to prevent your floor coverings from damage.

A high capacity for dirt capture and a great durability make our textile cleaning mats MULTICLEAN a popular choice for busy areas such as entrances, corridors, lift areas and reception desks.

<b>Specification</b>	<ul style="list-style-type: none"> <li>• Extraordinary dirt catching performance.</li> <li>• Skid resistant rubber back.</li> <li>• PVC-free.</li> <li>• Light and colour resistant.</li> <li>• 11 years warranty against significant loss of colour.</li> <li>• Washable up to 60° (at your chosen local laundry).</li> <li>• Made in Europe.</li> </ul>
<b>Applications</b>	Hallways, elevators, receptions, restrooms.
<b>Material</b>	High-twist nylon surface • Nitrile rubber backing .
<b>Standard widths</b>	60 x 85 cm, 85 x 150 cm, 115 x 175 cm, 115x 200 cm. Other sizes available on request.
<b>Height</b>	Approx. 10 mm.
<b>Weight</b>	2,40 kg/m <sup>2</sup> .
<b>Dirt absorption</b>	800 g/m <sup>2</sup> .
<b>Moisture absorption</b>	3 - 4 l/m <sup>2</sup> .
<b>Certifications</b>	EN 13501-1 / Cfl-s1 • EN 14041 Antistatic • NFSI High-Traction.

### Available Colours



Stone



Anthrazit





# LOGOCLEAN INDOOR SURFACE LAY BARRIER MAT



Entrance mats which incorporate brand logos and designs are a great way to display corporate, seasonal or promotional messages to your customers. With the floor representing a potential advertising space, why not let us help you exploit it. Using high print quality which delivers excellent colour reproduction, we can work with you to design and supply an innovative eye-catching LOGOCLEAN entrance mat that meets your specific corporate and marketing needs. Simply select your chosen colours from our extensive palette and then design your entrance mat. Manufactured to meet your exact requirements, these mats not only make a fantastic design statement, but also efficiently and effectively trap and retain dirt and moisture.

<b>Our LOGOCLEAN mats</b>	<ul style="list-style-type: none"> <li>• Prevent dirt and moisture from being brought into your building.</li> <li>• Feature a durable nylon surface and skid-resistant rubber backing.</li> <li>• Are available in special shapes and a huge range of special colours, including Pantone, HKS and RAL.</li> <li>• Are washable up to 60° (at your chosen local laundry).</li> <li>• Are manufactured in Europe.</li> </ul>
<b>Applications</b>	Entrances and indoor areas to feature: corporate identity; marketing messages and designs.
<b>Material</b>	Straight-set nylon surface • Nitrile rubber backing.
<b>Standard widths</b>	60 cm, 75 cm, 85 cm, 115 cm, 150 cm 200 cm. (Special widths on request, subject to a surcharge.)
<b>Standard lengths</b>	All lengths up to 400 cm (special lengths up to 700 cm on request, subject to a surcharge).
<b>Height</b>	Approx. 10 mm.
<b>Weight</b>	2,48 kg/m <sup>2</sup> .
<b>Dirt absorption</b>	600 g/m <sup>2</sup> .
<b>Moisture absorption</b>	3 - 4 l/m <sup>2</sup> .
<b>Certifications</b>	EN 13501-1 / Cfl-s1 • EN 14041 Antistatic • NFSI High-Traction.

### Available Colours



# ENTER DURABLE CARPETING WITH REP SURFACE

Recommended for normal requirements in indoor areas. Individual and cost-effective possible applications, for instance to supplement and extend entrance zones that are already fitted with Top Clean mats. Two colour variants of durable coarse and fine-ribbed mats are available to choose from. Customised production in any width and depth, or rolled product.

<b>Material</b>	Durable polypropylene that is 100% UV-resistant. At a height of 10 mm, the underside is made of anti-slip rubber. If necessary, the covering can be fixed to the floor using a carpet adhesive.
<b>Height</b>	Ca. 7 and ca. 10 mm.
<b>Dimensions Rolls</b>	10 mm height: 24,2 x 2 m; 7 mm height: 30,2 x 2 m.
<b>Ordering dimensions</b>	A measure tolerance of $\pm 10\%$ must be taken into account. <b>Please always order oversized.</b> Minor deviations in dimensions are no reason for complaint.



## ENTER ribbed carpet

### Heavy Duty Ribbed Carpet Standard Colours



010 Anthracite    020 Light Grey

### Fine Ribbed Carpet Standard Colours



010 Anthracite    020 Light Grey

Due to technical limitations colours are only approximate.

 For use indoors or in covered outdoor areas

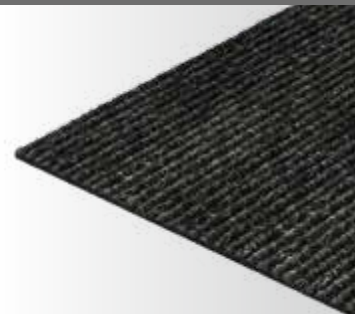

# MASTER COARSE HAISED REP MAT

Be it for an indoor area or covered entrances, coarse-haired ribbed mats are a good choice for effective cleaning. The surfaces made of sturdy needle punch absorb moisture and very reliably catch dirt. The mats can be produced in any required shape and size in accordance with your individual specifications. Three colours are available to choose from. A cost-effective rolled product measuring 12 x 2 m and 12 x 1 m is also offered.

<b>Material</b>	Coarse haired rep mat with flexible foam backing.
<b>Height</b>	Ca. 17 mm and 22 mm.
<b>Dimensions Rolls</b>	12 x 2 m and 12 x 1 m.



## MASTER coarse haired rep mat

Colours (height 17 mm only in anthracite)



Anthracite



Light Grey



Mottled Beige

Due to technical limitations colours are only approximate.

 For use indoors or in covered outdoor areas



# KARO AS MINI ULTRA FLAT HONEYCOMB RUBBER MAT

**ATTRACTIVE  
SPECIAL  
OFFERS**  
for whole pallets!

With its excellent, weatherproof rubber compound and outstanding adhesion, the KARO AS MINI meets the tough requirements in outdoor areas at frequently used entrances. Adapts to every surface. Studs on the underside allow water to drain off. With its small drainage holes and smooth surface, the KARO AS MINI is ideal for access with wheeled items such as wheelchairs, carts, suitcases and the like. Made to measure, sturdy and easy to clean. Customised production in any width and depth, and also special shapes.

<b>Material</b>	Solid rubber, abrasion-resistant and weatherproof.
<b>Design</b>	Honeycomb pattern.
<b>Underside</b>	Mat with raised studs for water drainage.
<b>Colour</b>	Black.
<b>Bottom</b>	Open.
<b>Mat Height</b>	Ca. 10 mm.
<b>Standard Size</b>	Ca. 150 x 100 cm.
<b>Custom made</b>	<ul style="list-style-type: none"> <li>– With any required dimensions,</li> <li>– Larger dimensions are produced in several parts and bonded together,</li> <li>– Special shapes as per drawing (e.g. triangular, trapezoidal or circular).</li> </ul>
<b>Connection</b>	Made of rubber.

Important: Always specify the required finished dimensions of the mat when placing an order.

## CONNECT connectors

The connectors can be used to quickly and easily connect the KARO AS MINI honeycomb rubber mats to cover large areas (around 3 mats per m). They can easily be pressed by hand into the opening provided on the mats and can just as easily be removed.

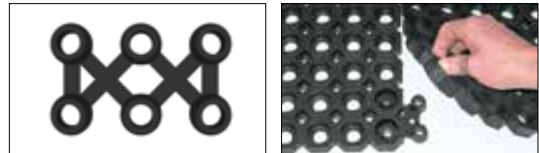

## KARO AS MINI rubber mat



# KARO AS HONEYCOMB RUBBER MAT

**ATTRACTIVE  
SPECIAL  
OFFERS**  
for whole pallets!

Durable mat made of abrasion-resistant and weatherproof solid rubber. Distinguished by high cleaning effect. Particularly suitable for wet and snowy areas. Optionally available with additional round brushes in Black, Red, Green, Yellow, Blue or Grey. Made to measure, sturdy and easy to clean. Customised production in any width and depth, and also special shapes.

<b>Material</b>	Solid rubber, abrasion-resistant and weatherproof.
<b>Design</b>	Honeycomb pattern.
<b>Underside</b>	Mat with 3 mm-high studs for water drainage.
<b>Colour</b>	Black.
<b>Bottom</b>	Open or closed.
<b>Mat Height</b>	Ca. 22 mm.
<b>Standard Size</b>	Ca. 119 x 98,5 cm and ca. 150 x 100 cm.
<b>Custom made</b>	<ul style="list-style-type: none"> <li>– With any required dimensions,</li> <li>– Larger dimensions are produced in several parts and bonded together,</li> <li>– Special shapes as per drawing (e.g. triangular, trapezoidal or circular).</li> </ul>
<b>Connectors</b>	Made of rubber, only for mats with an open bottom (see below).

Important: Always specify the required finished dimensions of the mat when placing an order.

## EASYCLEAN round brushes to intensify the cleaning effect

<b>Material</b>	Plastic brush body, nylon 6 bristles.
<b>Colours</b>	Black, Red, Green, Yellow, Blue or Grey.
<b>Quantity per m<sup>2</sup></b>	Honeycomb Rubber Mat KARO AS ca. 265 pie.
<b>Standard features</b>	Every second honeycomb fitted at an offset. Circumferential honeycomb row on the outside without fitting.



### KARO AS Gummiwabenmatte



# DOMINO HONEYCOMB RUBBER MAT

**ATTRACTIVE  
SPECIAL  
OFFERS**  
for whole pallets!

This hard-wearing rubber mat provides the ideal product properties for use in wet areas and outdoor areas. It can withstand intensive cleaning and any weather conditions. Available with open or closed base as required. Can easily be connected to cover large areas. Made to measure, sturdy and easy to clean. Customised production in any width and depth, and also special shapes.

<b>Material</b>	Solid rubber, abrasion-resistant and weatherproof.
<b>Design</b>	Honeycomb pattern.
<b>Underside</b>	Mat with a height of 22 mm, with 3 mm-high studs for water drainage. Mat with a height of 18 mm, without studs.
<b>Colour</b>	Black.
<b>Bottom</b>	Open or closed.
<b>Mat Height</b>	Ca. 18 and 22 mm.
<b>Standard Sizes</b>	Ca. 118 x 78 cm and ca. 150 x 100 cm.
<b>Custom made</b>	– With any required dimensions, – Larger dimensions are produced in several parts and bonded together, – Special shapes as per drawing (e.g. triangular, trapezoidal or circular).
<b>Connectors</b>	Made of rubber, only for mats with an open bottom (see below).
<b>Round brushes</b>	Not recommended for DOMINO.

Important: Always specify the required finished dimensions of the mat when placing an order.

## CONNECT connectors

The connectors can be used to quickly and easily connect the KARO AS and DOMINO honeycomb rubber mats to cover large areas (around 3 mats per m). They can easily be pressed by hand into the opening provided on the mats and can just as easily be removed.

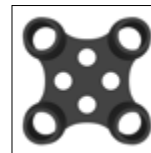

KARO AS

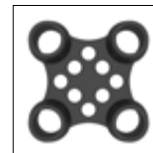

DOMINO



## DOMINO Gummiwabenmatte

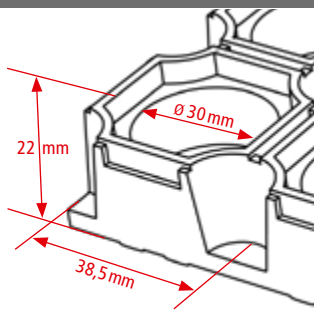

 For outdoor use

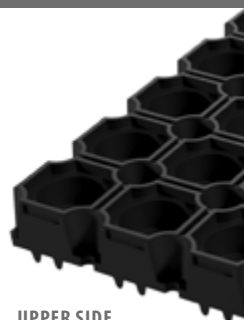

UPPER SIDE



LOWER SIDE



ROLLABLE

# WALK FINE RIBBED MAT



ALSO AVAILABLE: WALK EXTRA OIL-RESISTANT  
VARIANT (25% NBR) WITH 3 MM HEIGHT

Excellently suited to compensating height differences in the mat bed. Protects, for example, sensitive materials and tools. Recommended for vehicle fittings, tool trolleys, workbenches, drawers or packing tables.

<b>Material</b>	WALK: natural rubber (solid rubber). WALK EXTRA: oil-resistant nitrile rubber (25% NBR).
<b>Design</b>	Finely ribbed in the longitudinal direction.
<b>Underside</b>	Fabric textured.
<b>Height / Weight</b>	3 mm = 3,3 kg/m <sup>2</sup> , 4 mm = 4,5 kg/m <sup>2</sup> .
<b>Colour</b>	Black.
<b>Roll</b>	10 x 1 m.
<b>Special Sizes</b>	Available as custom-made variants or stamped parts.

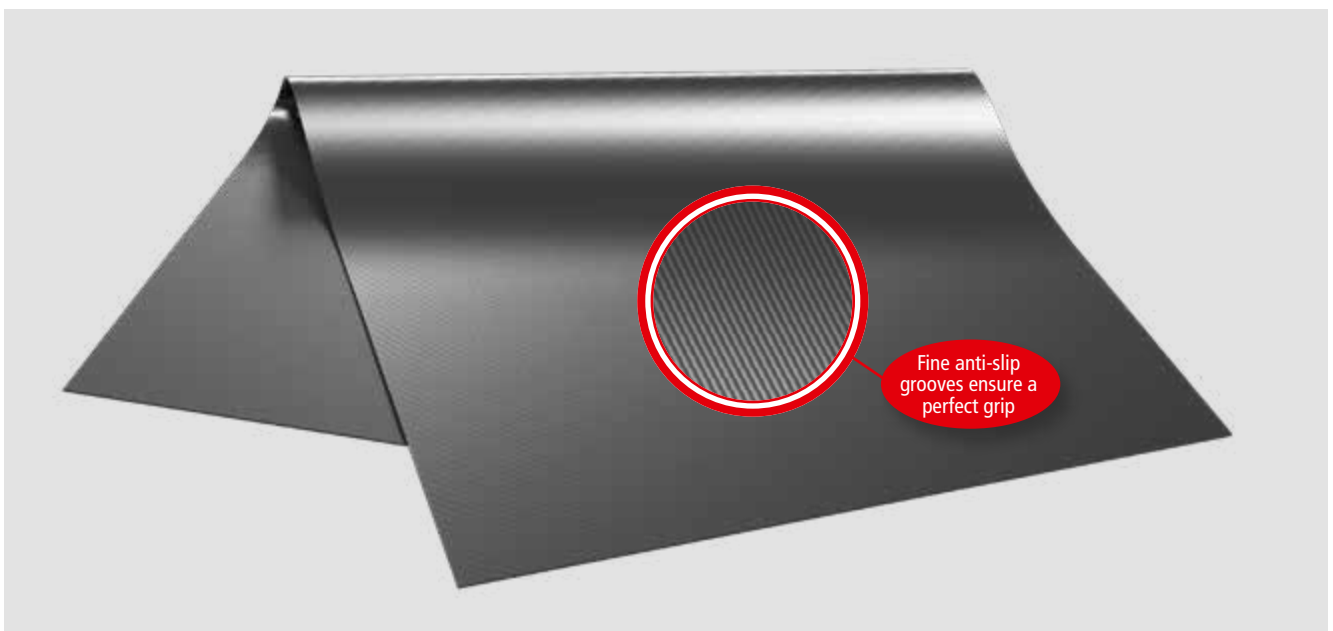

## WALK fine ribbed mat

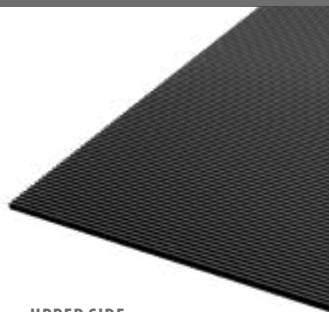

UPPER SIDE



LOWER SIDE



ROLLABLE



SPECIAL SHAPES



**FOOTFALL**

**FOOTFALL LTD**

Business Park, Ballybrit

Unit 55c Briarhill

GALWAY H91 TR2K

Unit 55c Briarhill Business Park, Ballybrit, Galway. H91 TR2K

Phone n. +353 91 792 500

e-Mail: [info@footfall.ie](mailto:info@footfall.ie)

Internet: [www.footfall.ie](http://www.footfall.ie)